

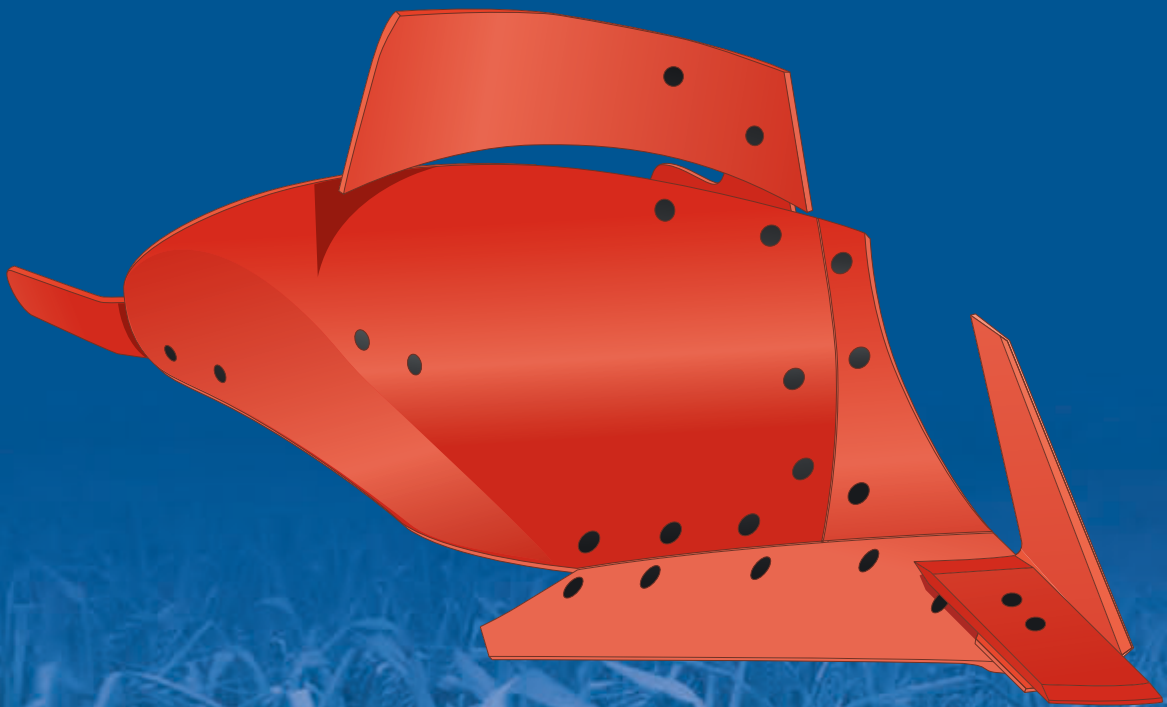

*Made for hard work*



*Catalogue*



*Made for hard work*

**Welcome to Mølbro.**

**We are proud to present our wide ranging program of tillage tools and hope you will be inspired by our new catalogue.**

**[www.molbro.com](http://www.molbro.com)**

Print 06/2016

# Table of contents catalogue



## Plough parts

### Wearing parts to fit:

AGROLUX AH ploughbody	6
AGROLUX AS ploughbody	7
AGROLUX AX ploughbody	8
AGROLUX FC ploughbody	9
AGROLUX FK ploughbody	10
AGROLUX KHN ploughbody	11
AGROLUX KH ploughbody	11
AGROLUX L, P and PP ploughbodies	11
AGROLUX ploughs	12
DURO ploughbodies	12
DOWDESWELL DD ploughbody	13
DOWDESWELL RCN, SCN, og UCN ploughbodies	14
FORTSCHRITT 30Z and 30ZS ploughbodies	15
FRAUGDE CAX and FK ploughbodies	16
FRAUGDE FA ploughbody	17
FRAUGDE FA and FKA ploughbodies	18
FRAUGDE FS and GS ploughbodies	19
FRAUGDE MS ploughbody	20
FRAUGDE 208 ploughbody	21
FRAUGDE plough	22
GOIZIN plough	23
GREGOIRE-BESSON plough	24
KRONE KG ploughs	56
KUHN RH/RLM ploughbodies, PP and C ploughbodies	25
KUHN H4 and H6 ploughbodies	26
KUHN Hb4 and HB6 ploughbodies	27
KUHN SK ploughbody	28
KUHN VL ploughbody	29
KUHN VS/N ploughbodies, ploughs	30
KVERNELAND ploughbody 53-series	31,32
KVERNELAND ploughbody nr. 1, 3	31,32
KVERNELAND ploughbody nr. 8, 9	32,33
KVERNELAND ploughbody nr. 14	34
KVERNELAND ploughbody nr. 28	35,36
KVERNELAND ploughbody nr. 12, 19	37,38
KVERNELAND ploughbody nr. 20, 30	39,40
KVERNELAND ploughbody ECOMAT	41
KVERNELAND ploughs	42
LEMKEN B ploughbody	43
LEMKEN BS 40 ploughbody	44
LEMKEN BS 42 ploughbody	45
LEMKEN BU ploughbody	46
LEMKEN DURAMAXX ploughbody	46
LEMKEN C and C40 ploughbodies	47
LEMKEN US 35 ploughbody	48
LEMKEN US 40 ploughbody	49
LEMKEN WG-WS ploughbodies	50
LEMKEN OPAL ploughs	50
MASSEY-FERGUSON FC ploughbody	51
MASSEY-FERGUSON AH ploughbody	52
MASSEY-FERGUSON AX ploughbody	53
MASSEY-FERGUSON FK ploughbody	54
MASSEY-FERGUSON ploughs	55
NAUD ploughs	56
NIEMEYER ploughs	57
PÖTTINGER ploughbodies 36W/41W	57
PÖTTINGER ploughbody 46W	58
RABE ploughbodies BP-321, 322, 323 PS/PSL	59
RABE ploughbodies BP-350 WS/WSL	60
RABE ploughbodies BP-2930, 2940 L	61
RABE universal ploughs	62
RABE universal ploughbodies (Lemken)	63
ROSS/Roudnice nad Labem ploughs	64
UNIA ploughbodies	65
VOGEL & NOOT ploughbody UN 400, ploughs	66
VOGEL & NOOT ploughbody WY 400	67
ØVERUM SR ploughbody	68
ØVERUM UC ploughbody	69
ØVERUM V ploughbody	70
ØVERUM XL ploughbody	71
ØVERUM XS ploughbody	72
ØVERUM XU ploughbody, ploughs	73
ØVERUM SM, SML and SMK ploughbody	74
	75

## Subsoiler parts

### Wearing parts to fit:

KVERNELAND Subsoiler "S"	76
KVERNELAND AGROMAT, Bonator Subsoiler	76
Standard Harrows	77
Standard Discs	78,79
HORSCH Harrows	80
BOURGAULT Harrows	81
KERNER Harrows	82
KÖCKERLING Harrows	82
LEMKEN Harrows, KOMPAKTOR Harrows	83,84
LEMKEN Drilling machine	84
VÅDERSTAD Drilling machine	85
VÅDERSTAD Harrows	86
AMAZONE Harrows	86

## EUROCARBIDE Wearing parts ploughs

### Wearing parts to fit:

AGROLUX, FORTSCHRITT FRAUGDE	87
GREGOIRE-BESSON, KUHN	87
KVERNELAND	88
LEMKEN	89
MASSEY-FERGUSON, RABE, ROSS, ØVERUM	90

## EUROCARBIDE Wearing parts subsoiler

### Wearing parts to fit:

HORSCH	91
KERNER	91
KVERNELAND	91
KÖCKERLING	91
LEMKEN	92
STANDARD HARROWS	92
VÅDERSTAD	92
KONGSKILDE	92

## Disc coulters and accessories

### Wearing parts to fit:

KVERNELAND	79,93
VÅDERSTAD	94
ØVERUM	94

## Information

MØLBRO Bolts and Nuts - BK system	95
MØLBRO <a href="http://www.molbro.com">www.molbro.com</a>	96
MØLBRO M7 products	97

© Copyright MØLBRO 2016  
EUROSHARE® Reg. trade mark. Reg. design.  
EUROPOINT® Reg. trade mark. Reg. design  
MØLBRO ®  
MØLBRO M7-points and MØLBRO M7-adapters are covered by US patent no.8875424





Bolts and nuts are now sold seperately in bolt boxes (BK no).











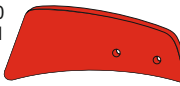



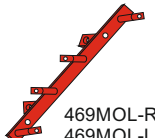

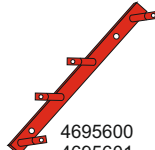





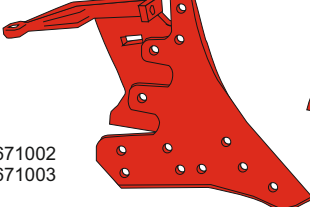

Here is our new Bolt box no. added to our catalogue, this makes it easy to find the right Bolt box no. for the Article no. when you order your parts. See page 80 in our catalogue for more information.

Parts to fit

## LEMKEN BS 42 ploughbodies

**Bolt box no.** **Article-no.** **Designation**

Mouldboards, shins and accessories

567MOL		3470860		BK009	3470860	Turbo-trashboard R
		3470861		BK009	3470861	Turbo-trashboard L
568MOL		3444030		BK141	469MOL-R	Stay with support R
		3444031		BK141	469MOL-L	Stay with support L
469MOL-R		3444020			4695600	Stay R
		3444021			4695601	Stay L
469MOL-L		3444010			567MOL	Support for stay, short
		3444011			568MOL	Support for stay, long
4695600		3444012		BK007	3451002	Shin R (10mm)
		3444013				
4695601		3444042		BK007	3451003	Shin L (10mm)
		3444043				
4671002		3451002		BK010	3451010	Shin R (8mm)
		3451003				
4671003		3451010		BK010	3451011	Shin L (8mm)
		3451011				
4695600		3444010		BK172	3444010	Mouldboard stripe R
		3444011		BK172	3444011	Mouldboard stripe L
4695601		3444020		BK172	3444020	Mouldboard stripe R
		3444021		BK172	3444021	Mouldboard stripe L
4671002		3444030		BK172	3444030	Mouldboard stripe R
		3444031		BK172	3444031	Mouldboard stripe L
4671003		3444042		BK173	3444042	Mouldboard stripe R
		3444043		BK173	3444043	Mouldboard stripe L
4671002		3444012		BK006	3444012	Rev. top stripe R
		3444013		BK006	3444013	Rev. top stripe L
4671003		4671002		BK140	4671002	Frog R
		4671003		BK140	4671003	Frog L



## Tightening of Mølbro bolts and nuts.

How to tight Mølbro tillage tools correctly.

Depending on which combination of bolts and nuts you are using you should be aware how hard you tighten your tillage tools. Please be aware that the specified torque is the maximum recommended torque. If you use other bolts or tighten the tillage tools more than the recommended torque Mølbro cannot guarantee for damage of your tillage tools.

Please note that tightening the nuts and bolts with pneumatic tools can also damage your tillage tools.

### Mølbro recommended tightening torques

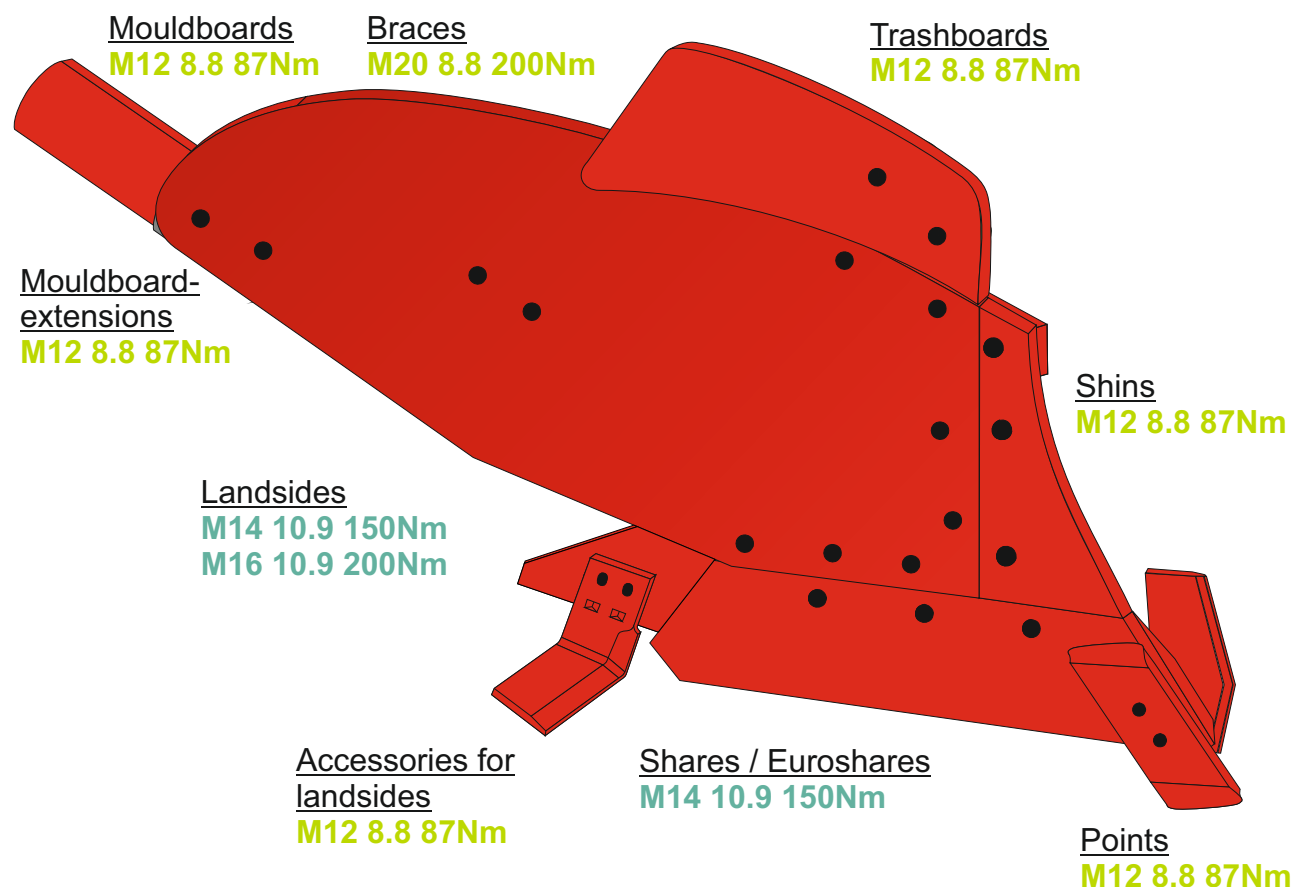

### The maximum torque according to DIN 912

DIN 912 Bolt / Nut	Strength		
	8.8	10.9	12.9
M 10	50 Nm	70 Nm	85 Nm
M 12	87 Nm	122 Nm	147 Nm
M 14	138 Nm	194 Nm	235 Nm
M 16	210 Nm	299 Nm	357 Nm
M 20	411 Nm	578 Nm	696 Nm



Parts to fit

# AGROLUX AH ploughbody

**Bolt box no. Article-no. Designation**

## Mouldboards, shins and accessories

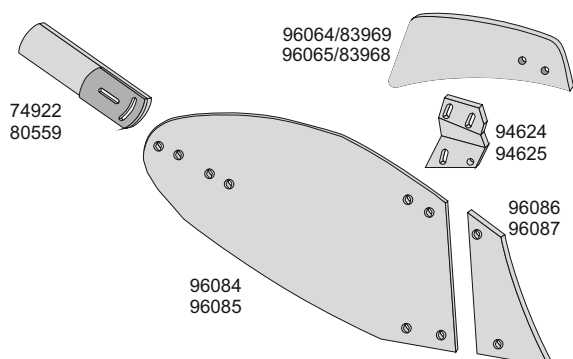

BK082	74922	Mouldboard extension R
BK082	80559	Mouldboard extension L
BK167	96064/83969	Turbo-trashboard R
BK167	96065/83968	Turbo-trashboard L
BK082	94624	Fittings for trashboard R
BK082	94625	Fittings for trashboard L
BK067	96084	Mouldboard R
BK067	96085	Mouldboard L
BK052	96086	Shin R
BK052	96087	Shin L

## Shares and points

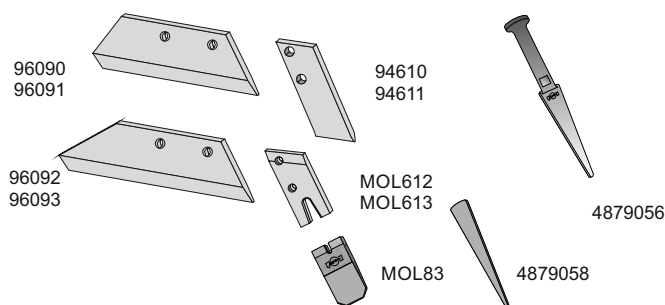

BK052	96090	Share 16" R
BK052	96091	Share 16" L
BK052	96092	Share 18" R
BK052	96093	Share 18" L
BK031	94610	Europoint R
BK031	94611	Europoint L
BK031	MOL612	M7-Adapter R
BK031	MOL613	M7-Adapter L
	MOL83	M7 point rev. R/L
	4879058	Wedge for M7 point
	4879056	Wedge for M7 point

## Landsides and share knives

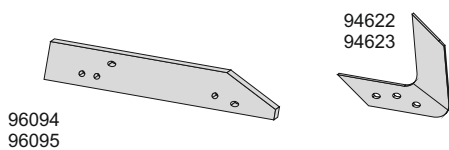

BK069	96094	Landside R
BK069	96095	Landside L
BK084	94622	Share knife R
BK084	94623	Share knife L

## Parts to mount on landsides

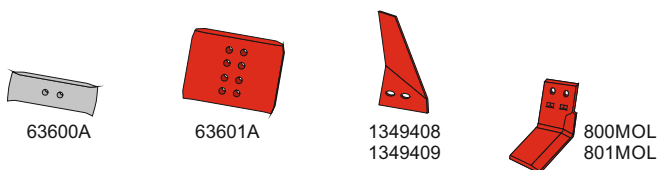

BK094	63600A	Wearig plate, rev. R&L
BK094	63601A	Wearing plate, rev. R&L
BK052	1349408	Sword coulter R
BK052	1349409	Sword coulter L
BK096	800MOL	Subsoiler blade R
BK096	801MOL	Subsoiler blade L



Parts to fit

## AGROLUX AS ploughbody

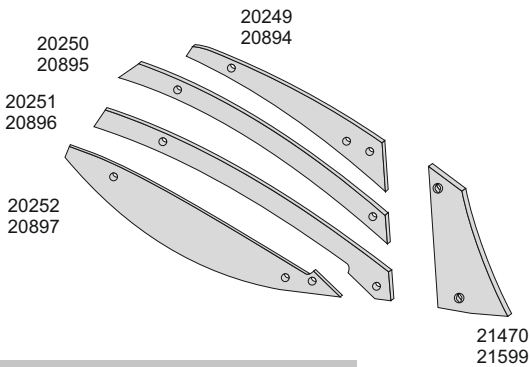
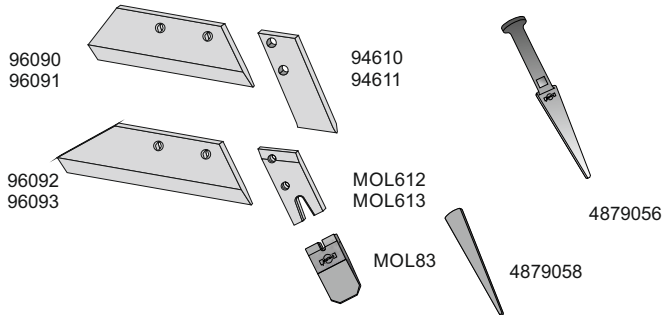
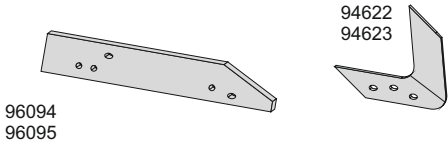
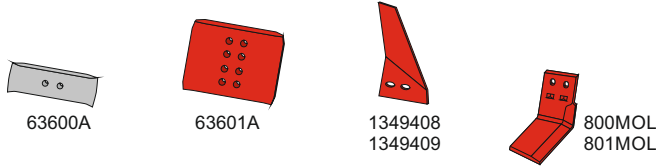
	<u>Bolt box no.</u>	<u>Article-no.</u>	<u>Designation</u>
<b>Mouldboards, shins and accessories</b>			
 <p>20250 20895</p> <p>20251 20896</p> <p>20252 20897</p> <p>20249 20894</p> <p>21470 21599</p>	BK058	20249	Mouldboard stripe R
	BK058	20894	Mouldboard stripe L
	BK052	20250	Mouldboard stripe R
	BK052	20895	Mouldboard stripe L
	BK052	20251	Mouldboard stripe R
	BK052	20896	Mouldboard stripe L
	BK058	20252	Mouldboard stripe R
	BK058	20897	Mouldboard stripe L
	BK052	21470	Shin R
	BK052	21599	Shin L
<b>Shares and points</b>			
 <p>96090 96091</p> <p>94610 94611</p> <p>96092 96093</p> <p>MOL612 MOL613</p> <p>MOL83</p> <p>4879056</p> <p>4879058</p>	BK052	96090	Share 16" R
	BK052	96091	Share 16" L
	BK052	96092	Share 18" R
	BK052	96093	Share 18" L
	BK031	94610	Europoint R
	BK031	94611	Europoint L
	BK031	MOL612	M7-Adapter R
	BK031	MOL613	M7-Adapter L
		MOL83	M7 point rev. R/L
		4879058	Wedge for M7 point
	4879056	Wedge for M7point	
<b>Landsides and share knives</b>			
 <p>96094 96095</p> <p>94622 94623</p>	BK069	96094	Landside R
	BK069	96095	Landside L
	BK084	94622	Share knife R
	BK084	94623	Share knife L
<b>Parts to mount on landsides</b>			
 <p>63600A</p> <p>63601A</p> <p>1349408 1349409</p> <p>800MOL 801MOL</p>	BK094	63600A	Wearing plate, rev. R&L
	BK094	63601A	Wearing plate, rev. R&L
	BK052	1349408	Sword coulter R
	BK052	1349409	Sword coulter L
	BK096	800MOL	Subsoiler blade R
	BK096	801MOL	Subsoiler blade L

### Did you know...

that your landsides will last 3-4 times longer if you use Mølbros wearing plate 63600A or 63601A.



Parts to fit

# AGROLUX AX ploughbody

**Bolt box no. Article-no. Designation**

## Mouldboards, shins and accessories

	<i>BK082</i> 74922	Mouldboard extension R
	<i>BK082</i> 80559	Mouldboard extension L
	<i>BK167</i> 96064/83969	Turbo-trashboard R
	<i>BK167</i> 96065/83968	Turbo-trashboard L
	<i>BK082</i> 94624	Fittings for trashboard R
	<i>BK082</i> 94625	Fittings for trashboard L
	<i>BK066</i> 94594	Mouldboard R
	<i>BK066</i> 94595	Mouldboard L
	<i>BK052</i> 94596	Shin R
	<i>BK052</i> 94597	Shin L

## Shares and points

	<i>BK052</i> 94598	Share 14" R
	<i>BK052</i> 94599	Share 14" L
	<i>BK052</i> 94600	Share 16" R
	<i>BK052</i> 94601	Share 16" L
	<i>BK052</i> 94602	Share 18" R
	<i>BK052</i> 94603	Share 18" L
	<i>BK031</i> 94610	Europoint R
	<i>BK031</i> 94611	Europoint L
	<i>BK031</i> MOL612	M7-Adapter R
	<i>BK031</i> MOL613	M7-Adapter L
	MOL83	M7 point rev. R/L
	4879058	Wedge for M7 point
	4879056	Wedge for M7point

## Landsides and share knives

	<i>BK074</i> 94606	Landside R
	<i>BK074</i> 94607	Landside L
	<i>BK084</i> 94622	Share knife R
	<i>BK084</i> 94623	Share knife L

## Parts to mount on landsides

	<i>BK094</i> 63600A	Wearing plate, rev. R&L
	<i>BK094</i> 63601A	Wearing plate, rev. R&L
	<i>BK052</i> 1349408	Sword coulters R
	<i>BK052</i> 1349409	Sword coulters L
	<i>BK096</i> 800MOL	Subsoiler blade R
	<i>BK096</i> 801MOL	Subsoiler blade L





Parts to fit

## AGROLUX FC ploughbody

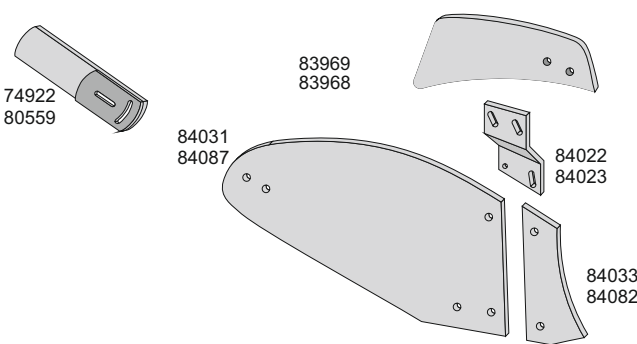
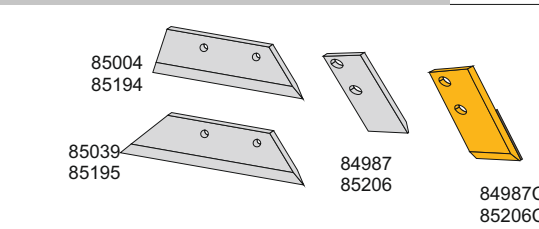
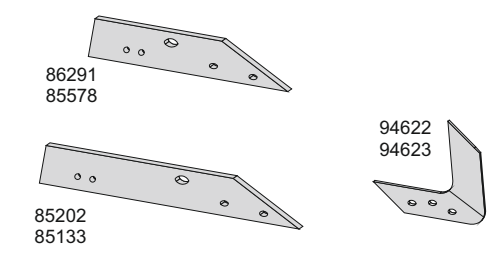
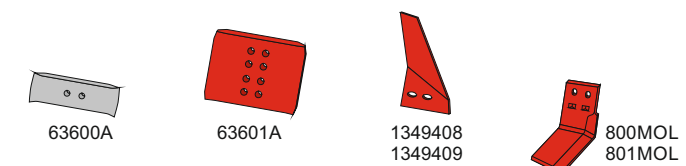
	<b>Bolt box no.</b>	<b>Article-no.</b>	<b>Designation</b>	
<b>Mouldboards, shins and accessories</b>				
	BK167	83969	Turbo-trashboard R	
	BK167	83968	Turbo-trashboard L	
		84022	Fittings for trashboard R	
		84023	Fittings for trashboard L	
	BK082	74922	Mouldboard extension R	
	BK082	80559	Mouldboard extension L	
	BK062	84031	Mouldboard R	
	BK062	84087	Mouldboard L	
	BK065	84033	Shin R	
	BK065	84082	Shin L	
	<b>Shares and points</b>			
		BK052	85004	Share 16" R
BK052		85194	Share 16" L	
BK052		85039	Share 18" R	
BK052		85195	Share 18" L	
BK031		84987C	EUROCARBIDE M5 point R	
BK031		85206C	EUROCARBIDE M5 point L	
BK031		84987	Europoint R	
BK031		85206	Europoint L	
<b>Landsides and share knives</b>				
	BK084	94622	Share knife R	
	BK084	94623	Share knife L	
	BK073	86291	Landside, short R	
	BK073	85578	Landside, short L	
	BK073	85202	Landside, long R	
	BK073	85133	Landside, long L	
	<b>Parts to mount on landsides</b>			
		BK094	63600A	Wearing plate, rev. R&L
BK094		63601A	Wearing plate, rev. R&L	
BK052		1349408	Sword coulter R	
BK052		1349409	Sword coulter L	
BK096		800MOL	Subsoiler blade R	
BK096		801MOL	Subsoiler blade L	



Parts to fit

# AGROLUX FK ploughbody

**Bolt box no. Article-no. Designation**

## Mouldboards, shins and accessories

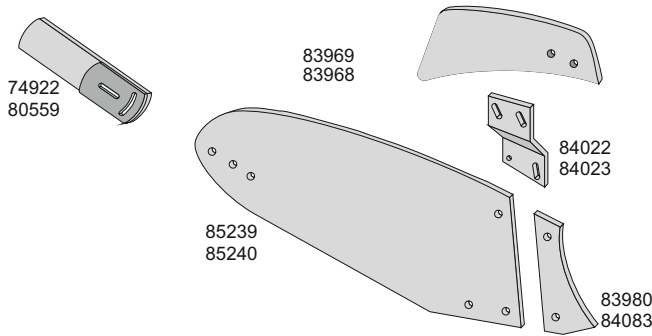

BK167	83969	Turbo-trashboard R
BK167	83968	Turbo-trashboard L
	84022	Fittings for trashboard R
	84023	Fittings for trashboard L
BK063	85239	Mouldboard R
BK063	85240	Mouldboard L
BK082	74922	Mouldboard extension R
BK082	80559	Mouldboard extension L
BK065	83980	Shin R
BK065	84083	Shin L

## Shares and points

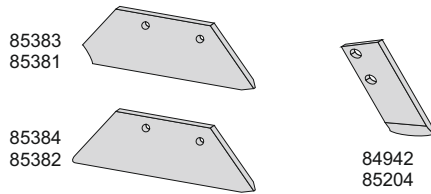

BK052	85383	Share 16" R
BK052	85381	Share 16" L
BK052	85384	Share 18" R
BK052	85382	Share 18" L
BK031	84942	Europoint R
BK031	85204	Europoint L

## Landsides and share knives

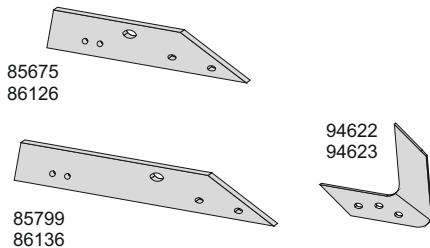

BK084	94622	Share knife R
BK084	94623	Share knife L
BK073	85675	Landside, short R
BK073	86126	Landside, short L
BK073	85799	Landside, long R
BK073	86136	Landside, long L

## Parts to mount on landsides

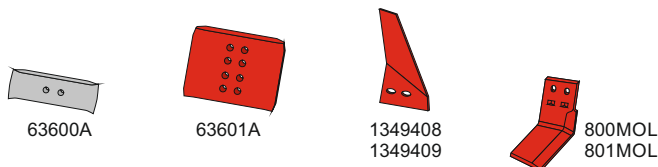

BK094	63600A	Wearing plate, rev. R&L
BK094	63601A	Wearing plate, rev. R&L
BK052	1349408	Sword coulter R
BK052	1349409	Sword coulter L
BK096	800MOL	Subsoiler blade R
BK096	801MOL	Subsoiler blade L

Parts to fit  
**AGROLUX KHN ploughbody**

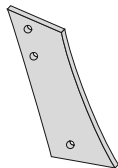
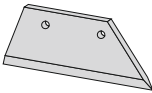
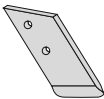

	<b>Bolt box no.</b>	<b>Article-no.</b>	<b>Designation</b>
<b>Shins</b>			
 <p>950025-05 950041-13</p>	BK121	950025-05	Shin-R
	BK121	950041-13	Shin-L
<b>Shares and points</b>			
 <p>950024-89 950041-20</p>	BK119	950024-89	Share 16" H
	BK119	950041-20	Share 16" V
 <p>950024-90 950041-18</p>	BK119	950024-90	EUROPOINT R
	BK119	950041-18	EUROPOINT L

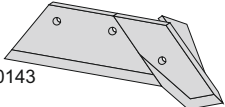
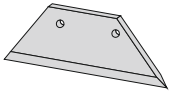
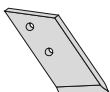
Parts to fit  
**AGROLUX KH poughbody**

	<b>Bolt box no.</b>	<b>Article-no.</b>	<b>Designation</b>
<b>Shares and points</b>			
 <p>91100143</p>	BK121	91100143	Reinforced ploughshare 16" R
 <p>950006-84</p>	BK119	950006-84	Share 16" R
	BK119	950006-75	EUROPOINT R
 <p>950006-75</p>			

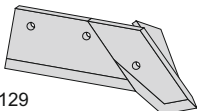

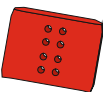
Parts to fit  
**AGROLUX L, P and PP ploughbody**

	<b>Bolt box no.</b>	<b>Article-no.</b>	<b>Designation</b>
<b>Shares and points</b>			
 <p>91100129</p>	BK121	91100129	Reinforced ploughshare 16" R

<b>Parts to mount on landsides</b>			
 <p>63600A</p>	BK094	63600A	Wearing plate, rev. R&L
 <p>63601A</p>	BK094	63601A	Wearing plate, rev. R&L
 <p>1349408</p>	BK052	1349408	Sword coulter R
 <p>800MOL</p>	BK096	800MOL	Subsoiler blade R

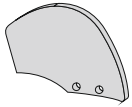
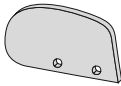
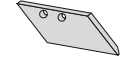
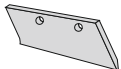

Parts to fit

# AGROLUX ploughs

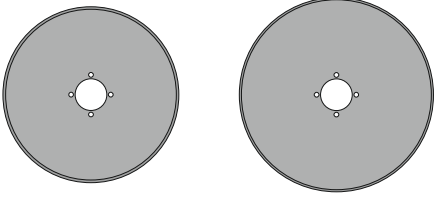
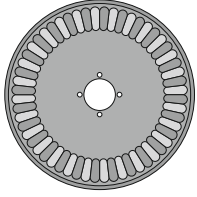
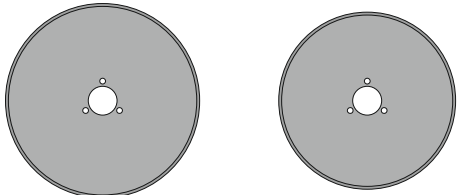
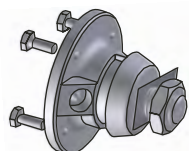
		<u>Bolt box no.</u>	<u>Article-no.</u>	<u>Designation</u>
<b>Skim shares and skim mouldboards</b>				
80645		BK003	80645	Skim mouldboard R
	80644	BK052	91803	Skim mouldboard R
BK052		91804	Skim mouldboard L	
91803		BK050	80644	Skim share R
		BK052	91801	Skim share R
91801		BK052	91802	Skim share L
		BK052	93055	Skim share R
91802		BK052	93054	Skim share L
				



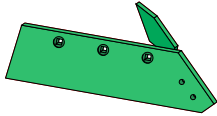



		<u>Bolt box no.</u>	<u>Article-no.</u>	<u>Designation</u>
<b>Disc coulters and accessories</b>				
72547		72547	72547	Disc coulters 18" R&L
		80662	80662	Disc coulters 20" R&L
80663		80663	80663	Disc coulters, rippled 20" R&L
		950004-74	950004-74	Disc coulters 20" R&L
950008-37		950008-37	950008-37	Disc coulters 18" R&L
		80966	80966	Cover for disc coulters R&L
80967AH		80967AH	80967AH	Hub for disc coulters M30 R
		80967AV	80967AV	Hub for disc coulters M30 L

Parts to fit  
**DURO ploughbody**

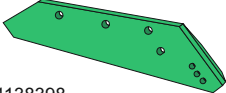

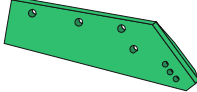

		<u>Bolt box no.</u>	<u>Article-no.</u>	<u>Designation</u>
<b>Shares and points</b>				
 6430 6429	 6432 6431	BK171	6430	EUROSHARE 16" R
		BK171	6429	EUROSHARE 16" L
		BK094	6432	Rev. Point R
		BK094	6431	Rev. Point L

Parts to fit  
**DOWDESWELL DD ploughbody**

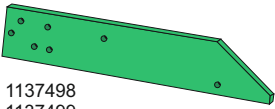
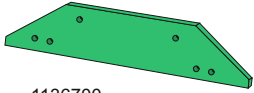
		<u>Bolt box no.</u>	<u>Article-no.</u>	<u>Designation</u>
<b>Shins</b>				
 1136698 1136699		BK058	1136698	Shin R
		BK099	1136699	Shin L











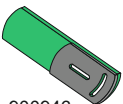



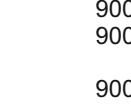
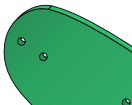

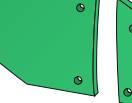

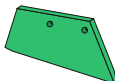
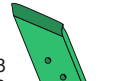
		<u>Bolt box no.</u>	<u>Article-no.</u>	<u>Designation</u>		
<b>Shares and points</b>						
 1138398 1138399	 1176598 1176599	BK092	1138398	EUROSHARE 18" R		
		BK092	1138399	EUROSHARE 18" L		
		BK089	1176598	EUROPOINT rev. R		
		BK089	1176599	EUROPOINT rev. L		
 1161598 1161599	 901953 901954	 9053MOLC 9054MOLC	 114MOL R 114MOL L	BK092	1161598	EUROSHARE 16" R
				BK092	1161599	EUROSHARE 16" L
		BK090	901953	EUROPOINT rev. R		
		BK090	901954	EUROPOINT rev. L		
		BK095	9053MOLC	EUROCARBIDE M3 point R		
		BK095	9054MOLC	EUROCARBIDE M3 point L		
			114MOL R	Share knife R		
			114MOL L	Share knife L		

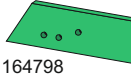
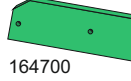
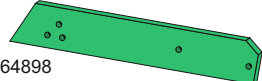
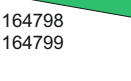
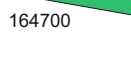
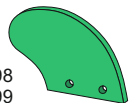
		<u>Bolt box no.</u>	<u>Article-no.</u>	<u>Designation</u>
<b>Landsides</b>				
 1137498 1137499	 1136700	BK091	1137498	Landside, long R
		BK091	1137499	Landside, long L
		BK090	1136700	Landside rev. R&L

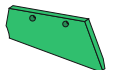
		<u>Bolt box no.</u>	<u>Article-no.</u>	<u>Designation</u>		
<b>Parts to mount on landsides</b>						
 63600A	 63601A	 1349408 1349409	 800MOL 801MOL	BK094	63600A	Wearing plate, rev. R&L
				BK094	63601A	Wearing plate, rev. R&L
				BK052	1349408	Sword coulter R
				BK052	1349409	Sword coulter L
				BK096	800MOL	Subsoiler blade R
				BK096	801MOL	Subsoiler blade L

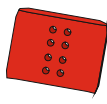

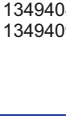





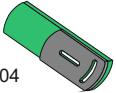
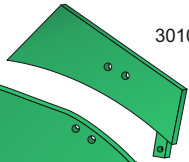
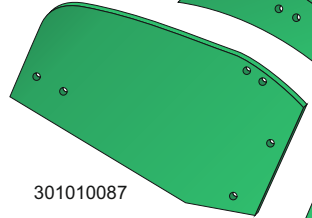

Parts to fit:

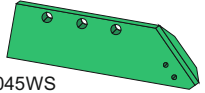
## DOWDESWELL RCN, SCN, UCN ploughbodies

		<u>Bolt box no.</u>	<u>Article-no.</u>	<u>Designation</u>
<b>Mouldboards, shins and accessories</b>				
	900946		900946	Mouldboard extension R
	900947		900947	Mouldboard extension L
	900666		900666	Mouldboard R, SCN
	900667		900667	Mouldboard L, SCN
	900643		900643	Mouldboard R, UCN
	900644		900644	Mouldboard L, UCN
	900643	BK069	900936	Shin R, SCN
	900644	BK069	900937	Shin L, SCN
	900649	BK069	900649	Shin R, UCN
	900650	BK069	900650	Shin L, UCN
<b>Shares and points</b>				
	147898	BK090	114798	Share R
	147899	BK090	147899	Share L
	147298	BK131	147298	Rev. point R
	147299	BK131	147299	Rev. point L
<b>Landsides</b>				
	164798	BK090	164798	Landside, short R
	164799	BK090	164799	Landside, short L
	164700	BK090	164700	Landside, rev. R&L
	164898	BK091	164898	Landside, long R
	164899	BK091	164899	Landside, long L
<b>Skim shares and skim mouldboards</b>				
	048198		048198	Skim mouldboard R
	048199		048199	Skim mouldboard L
	048098	BK027	048098	Skim share R
	048099	BK027	048099	Skim share L
<b>Parts to mount on landsides</b>				
	63600A	BK094	63600A	Wearing plate, rev. R&L
	63601A	BK094	63601A	Wearing plate, rev. R&L
	1349408	BK052	1349408	Sword coulter R
	1349409	BK052	1349409	Sword coulter L
	800MOL	BK096	800MOL	Subsoiler blade R
	801MOL	BK096	801MOL	Subsoiler blade L

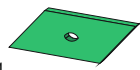
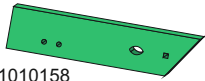
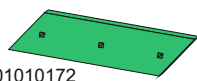
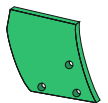
Parts to fit:

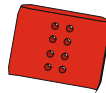
## FORTSCHRITT 30Z and 30ZS ploughbodies

	<u>Bolt box no.</u>	<u>Article-no.</u>	<u>Designation</u>
<b>Mouldboards, shines and accessories</b>			
	BK016	301053847	Turbo-trashboard R
	BK015	301010104	Mouldboard extension R
	BK010	301010088	Shin R
	BK011	301010087	Mouldboard R
<b>Shares, points and accessories</b>			
	BK037	301000045WS	EUROSHARE R
	BK037	301000045	EUROSHARE R
	BK037	301000045A	Ploughshare R
	BK094	93105	Rev. Point R
	BK095	73091	Share knife R
<b>Landsides</b>			
	BK134	301010171	Landside, short R
		301010158	Landside, long R
	BK036	301010172	Landside, long R
<b>Skim shares and skim mouldboards</b>			
	BK010	301010086	Skim mouldboard R
	BK009	301000035	Skim share R
<b>Parts to mount on landsides</b>			
	BK094	63600A	Wearing plate, rev. R&L
	BK094	63601A	Wearing plate, rev. R&L
	BK052	1349408	Sword coulter R
	BK096	800MOL	Subsoiler blade R



Parts to fit:

## FRAUGDE CAX ploughbody

	<u>Bolt box no.</u>	<u>Article-no.</u>	<u>Designation</u>
<b>Shares, points and accessories</b>			
93114	BK095	73091	Share knife R
	BK094	93105	EUROPOINT Rev. R
	BK095	9310MOLC	EUROCARBIDE M3 point R
93116	BK123	93114	Share f/rev. point 14" R
	BK123	93116	Share f/rev. point 16" R
93003	BK123	93003	Ploughshare 16" R

Parts to fit:







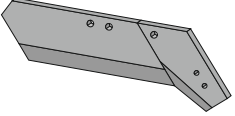

## FRAUGDE FK ploughbody

<b>Shares, points and accessories</b>			
93047	BK123	93047	Ploughshare 14" R
<b>Landside</b>			
93660	93660		Landside R
<b>Parts to mount on landsides</b>			
63600A	BK094	63600A	Wearing plate, rev. R&L
63601A	BK094	63601A	Wearing plate, rev. R&L
1349408	BK052	1349408	Sword coulter R
800MOL	BK096	800MOL	Subsoiler blade R

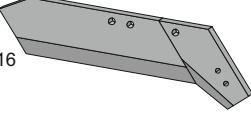
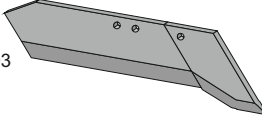
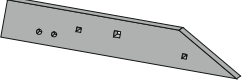
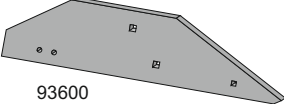

Parts to fit:

## FRAUGDE FA ploughbody

	<u>Bolt box no.</u>	<u>Article-no.</u>	<u>Designation</u>
<b>Shares, points and accessories</b>			
 93114	BK095	73091	Share knife R
	BK094	93105	EUROPOINT Rev. R
	BK095	9310MOLC	EUROCARBIDE M3 point R
 93105			
 9310MOLC			
 73091			
 93116	BK123	93114	Share f/rev. point 14" R
	BK123	93116	Share f/rev. point 16" R
 93003	BK123	93003	Ploughshare 16" R
<b>Landsides</b>			
 93650		93650	Landside, low R
 93600		93600	Landside, tall R
<b>Parts to mount on landsides</b>			
 63600A	BK094	63600A	Wearing plate, rev. R&L
 63601A	BK094	63601A	Wearing plate, rev. R&L
 1349408	BK052	1349408	Sword coulter R
 800MOL	BK096	800MOL	Subsoiler blade R







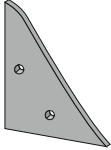
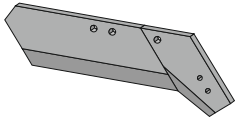

### Did you know...

that our sword coulter 1349408/1349409 will reduce the risk of damages from stones by more than 90% if you are using wide tires.



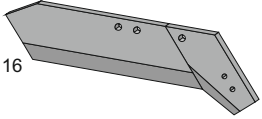
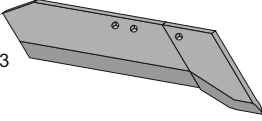
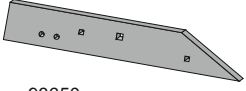
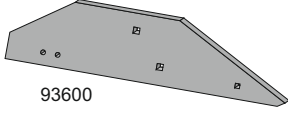

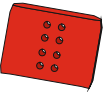





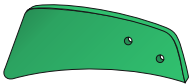

Parts to fit

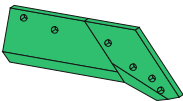
# FRAUGDE FA and FKA ploughbodies

	<u>Bolt box no.</u>	<u>Article-no.</u>	<u>Designation</u>
<b>Shin</b>			
 93201	BK119	93201	Shin R
<b>Shares, points and accessories</b>			
 93114	BK095	73091	Share knife R
 93105	BK094	93105	•EUROPOINT Rev. R
 9310MOLC	BK095	9310MOLC	EUROCARBIDE M3 point R
 93116	BK123	93114	Share f/rev. point 14" R
	BK123	93116	Share f/rev. point 16" R
	BK123	93003	Ploughshare 16" R
 93116			
 93003			
<b>Landsides</b>			
 93650		93650	Landside, low R
 93600		93600	Landside, tall R
<b>Parts to mount on landsides</b>			
 63600A	BK094	63600A	Wearing plate, rev. R&L
 63601A	BK094	63601A	Wearing plate, rev. R&L
 1349408	BK052	1349408	Sword coulter R
 800MOL	BK096	800MOL	Subsoiler blade R

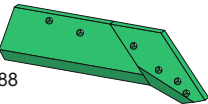
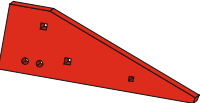
Parts to fit:

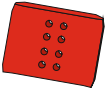
## FRAUGDE FS and GS ploughbodies











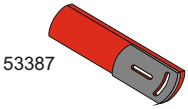
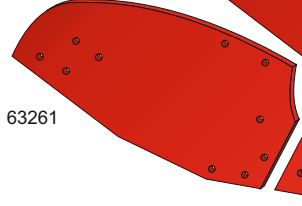
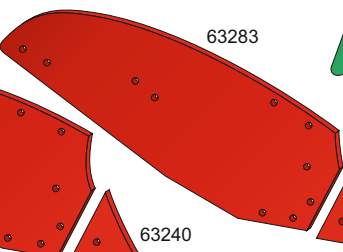

			<u>Bolt box no.</u>	<u>Article-no.</u>	<u>Designation</u>				
<b>Accessories</b>									
73/63-300		73/63-310		BK167 73/63-300 73/63-310	Turbo-trashboard R Fittings for trashboard R				
<b>Shares, points and accessories</b>									
53087		53090				BK095 73091 BK094 53090 BK095 5309MOLC	Share knife R EUROPOINT Rev. R EUROCARBIDE M3 point R		
53088						BK100 53087	Share f/rev. 14" R		
						BK100 53088	Share f/rev. 16" R		
<b>Landside</b>									
53684						BK118 53684	Landside, short R		
<b>Parts to mount on landsides</b>									
63600A		63601A		1349408		800MOL		BK094 63600A BK094 63601A BK052 1349408 BK096 800MOL	Wearing plate, rev. R&L Wearing plate, rev. R&L Sword coulter R Subsoiler blade R

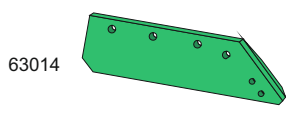
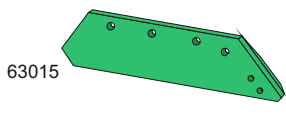
### Did you know...

that if your plough is equipped with Mølbros shares and points it is always the point which enters the soil first.

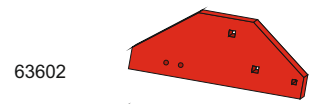
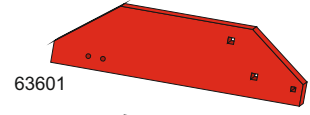
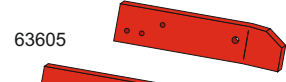
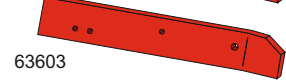
Parts to fit

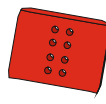
# FRAUGDE MS ploughbody

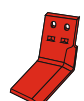
	<u>Bolt box no.</u>	<u>Article-no.</u>	<u>Designation</u>
<b>Mouldboards, shins and accessories</b>			
	BK167	73/63-300	Turbo-trashboard R
		73/63-310	Fittings for trashboard R
	BK056	63283	Mouldboard R
	BK056	63261	Mouldboard R
	BK082	53387	Mouldboard extension R
	BK053	63240	Shin R
<b>Shares, points and accessories</b>			
	BK100	63014	EUROSHARE 14" R
	BK100	63015	EUROSHARE 16" R
	BK095	73091	Share knife R
	BK094	53090	EUROPOINT Rev. R
	BK095	5309MOLC	EUROCARBIDE M3 point R
<b>Landsides</b>			
	BK118	63602	Landside, short R
	BK118	63601	Landside, long R
	BK103	63605	Landside, short, low R
	BK103	63603	Landside, long, low R
<b>Parts to mount on landsides</b>			
	BK094	63600A	Wearing plate, rev. R&L
	BK094	63601A	Wearing plate, rev. R&L
	BK052	1349408	Sword coulter R
	BK096	800MOL	Subsoiler blade R



Parts to fit:

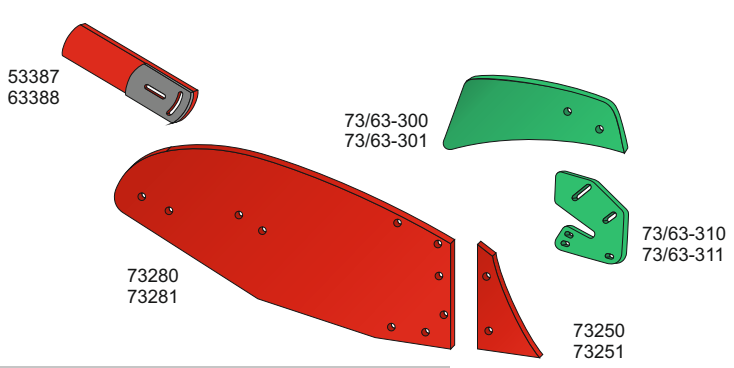
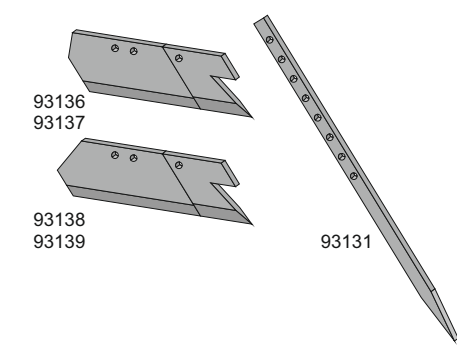
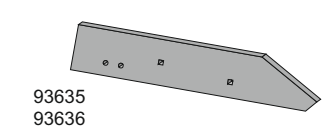
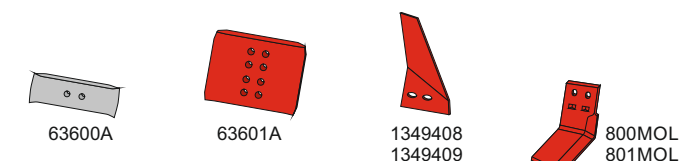

## FRAUGDE 208 ploughbody

		<u>Bolt box no.</u>	<u>Article-no.</u>	<u>Designation</u>
<b>Mouldboards, shins and accessories</b>				
 <p>53387 63388</p> <p>73280 73281</p> <p>73/63-300 73/63-301</p> <p>73/63-310 73/63-311</p> <p>73250 73251</p>	BK167	73/63-300	Turbo-trashboard R	
	BK167	73/63-301	Turbo-trashboard L	
		73/63-310	Fittings for trashboard R	
		73/63-311	Fittings for trashboard L	
	BK082	53387	Mouldboard extension R	
	BK082	63388	Mouldboard extension L	
	BK056	73280	Mouldboard R	
	BK056	73281	Mouldboard L	
	BK052	73250	Shin R	
	BK052	73251	Shin L	
<b>Shares and points</b>				
 <p>93136 93137</p> <p>93138 93139</p> <p>93131</p>		93131	Barpoint R&L	
	BK099	93136	Share for barpoint 14" R	
	BK099	93137	Share for barpoint 14" L	
	BK099	93138	Share for barpoint 16" R	
	BK099	93139	Share for barpoint 16" L	
<b>Landside</b>				
 <p>93635 93636</p>	BK050	93635	Landside R	
	BK050	93636	Landside L	
<b>Parts to mount on landsides</b>				
 <p>63600A</p> <p>63601A</p> <p>1349408 1349409</p> <p>800MOL 801MOL</p>	BK094	63600A	Wearing plate, rev. R&L	
	BK094	63601A	Wearing plate, rev. R&L	
	BK052	1349408	Sword coulter R	
	BK052	1349409	Sword coulter L	
	BK096	800MOL	Subsoiler blade R	
	BK096	801MOL	Subsoiler blade L	

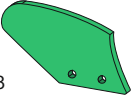

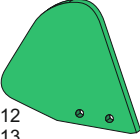
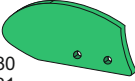
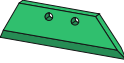
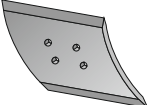

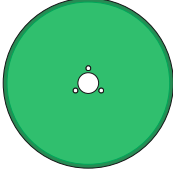
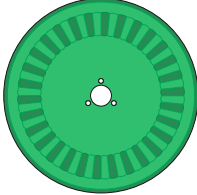
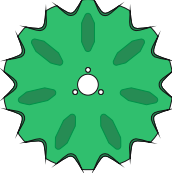
Parts to fit

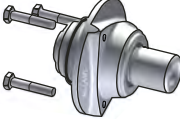
## FRAUGDE ploughs

		<u>Bolt box no.</u>	<u>Article-no.</u>	<u>Designation</u>
<b>Skim shares and skim mouldboards</b>				
66878		BK026	66878	Skim mouldboard R
56873 66873V		BK004	56873	Skim share, short R
		BK004	66873V	Skim share, short L
76812 76813		BK026	76812	Skim mouldboard R
		BK026	76813	Skim mouldboard L
66880 66881		BK026	66880	Skim mouldboard R
		BK026	66881	Skim mouldboard L
66868 66869		BK004	66868	Skim share, long R
		BK004	66869	Skim share, long L
		BK004	66868/ 66869	Skim share, R&L
96550			96550	Skim share, rev. R

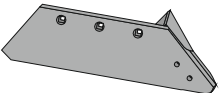
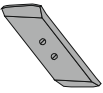
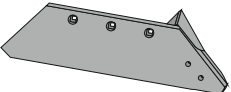
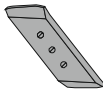
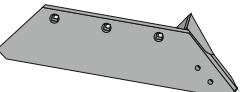
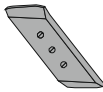
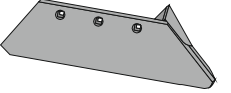
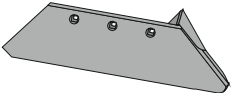
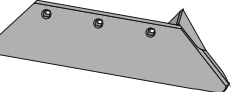
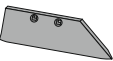
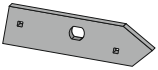
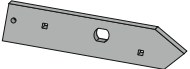
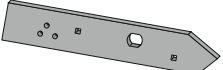
		<u>Bolt box no.</u>	<u>Article-no.</u>	<u>Designation</u>
<b>Disc coulters and accessories</b>				
56112		56112	56112	Disc coulters 18" R&L
56114		56114	56114	Disc coulters, rippled 20" R&L
56115		56115	56115	Disc coulters, notched 18" R&L
56156		56156	56156	Universal cover for hub R&L
60624		60624	60624	Hub for disc coulters $\varnothing$ 30 mm R&L

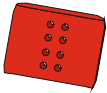
Parts to fit:  
**GOIZIN ploughs**

	<b>Bolt box no.</b>	<b>Article-no.</b>	<b>Designation</b>	
<b>Shares</b>				
010406 010454			010406 EUROSHARE 14" R 010456 EUROSHARE 14" L	
010506 010556			010506 EUROSHARE 15" R 010556 EUROSHARE 15" L	
010606 010656			010606 EUROSHARE 16" R 010656 EUROSHARE 16" L	
010444 010494			010004 EUROPOINT Rev. R 010054 EUROPOINT Rev. L  010104 EUROPOINT Rev. R 010154 EUROPOINT Rev. L	
010544 010594			010444 EUROSHARE 14" R 010494 EUROSHARE 14" L  010544 EUROSHARE 15" R 010594 EUROSHARE 15" L	
010644 010694			010644 EUROSHARE 16" R 010694 EUROSHARE 16" L	
<b>Skim shares</b>				
010732D 010782G			010732D Skim share R 010782G Skim share L	
<b>Landsides</b>				
010334 010384			010334 Landside R 010384 Landside L	
010534 010584			010534 Landside R 010584 Landside L	
01053MOL 01058MOL			01053MOL Landside R 01058MOL Landside L	
<b>Parts to mount on landsides</b>				
				<i>BK094</i> 63600A Wearing plate, rev. R&L <i>BK094</i> 63601A Wearing plate, rev. R&L <i>BK052</i> 1349408 Sword coulter R <i>BK052</i> 1349409 Sword coulter L <i>BK096</i> 800MOL Subsoiler blade R <i>BK096</i> 801MOL Subsoiler blade L

Parts to fit:

# GREGOIRE-BESSON ploughs

		<u>Bolt box no.</u>	<u>Article-no.</u>	<u>Designation</u>
<b>Mouldboard and shin</b>				
			173404 173403	Mouldboard R Mouldboard L
		BK052	173326	Shin R
		BK052	173325	Shin L
		BK052	173322	Shin R
		BK052	173321	Shin L
<b>Shares, points and accessories</b>				
		BK114	173424	EUROSHARE 14" R
		BK114	173423	EUROSHARE 14" L
		BK113	173614	EUROSHARE 16" R
		BK113	173613	EUROSHARE 16" L
		BK113	173614-14	EUROSHARE 16" R 14mm
		BK113	173613-14	EUROSHARE 16" L 14mm
		BK113	173802	EUROSHARE 18" R
		BK113	173801	EUROSHARE 18" L
		BK095	173332	EUROPOINT Rev. R
		BK095	173331	EUROPOINT Rev. L
		BK096	173MOL R	Share knife R (173324)
		BK096	173MOL L	Share knife L (173323)
		BK095	MOL332C	EUROCARBIDE M3 point R
		BK095	MOL331C	EUROCARBIDE M3 point L
			172417	Share 14" L
			172418	Share 14" R
			172612	Share 16" L
			172613	Share 16" R
<b>Skim shares</b>				
		BK052	19114	Skim shares R
		BK052	19113	Skim shares
		BK052	19172	Skim mouldboard R
		BK052	19171	Skim mouldboard L
			19122	Skim mouldboard R
			19121	Skim mouldboard L
<b>Landsides</b>				
		BK036	177312	Landside R&L
		BK036	177MOL	Landside R&L
		BK036	173338	Landside, short R
		BK036	173337	Landside, short L
		BK036	173388	Landside, rev. R&L
		BK036	177349	Wearing plate, rev. R&L
<b>Parts to mount on landsides</b>				
		BK094	63600A	Wearing plate, rev. R&L
		BK094	63601A	Wearing plate, rev. R&L
		BK052	1349408	Sword coulter R
		BK052	1349409	Sword coulter L
		BK096	800MOL	Subsoiler blade R
		BK096	801MOL	Subsoiler blade L



Parts to fit

## KUHN RH/RLM ploughbodies

	<u>Bolt box no.</u>	<u>Article-no.</u>	<u>Designation</u>
<b>Shin</b>			
		616104 616105	Mouldboard R Mouldboard L
	BK069	619038	Shin R
	BK069	619039	Shin L
<b>Shares, points and accessories</b>			
	BK095	622180	EUROPOINT rev. R
	BK095	622181	EUROPOINT rev. L
	BK095	MOL180C	EUROCARBIDE M3 point R
	BK095	MOL181C	EUROCARBIDE M3 point L
	BK095	622128	EUROPOINT Z- R
	BK095	622129	EUROPOINT Z- L
	BK095	622174	EUROPOINT Z- reinforc. R
	BK095	622175	EUROPOINT Z- reinforc. L
	BK112	622140	Share f/rev. point 14" R
	BK112	622141	Share f/rev. point 14" L
	BK112	622142	Share f/rev. point 16" R
	BK112	622143	Share f/rev. point 16" L
	BK095	270MOL	Share knife R
	BK095	271MOL	Share knife L
<b>Landsides</b>			
	BK069	279028	Landside, short R
	BK069	279029	Landside, short L
	BK057	279030	Landside, long R
	BK057	279031	Landside, long L
		226100	Steering plate R&L

Parts to fit:

## KUHN PP and C ploughbodies

	<u>Bolt box no.</u>	<u>Article-no.</u>	<u>Designation</u>
<b>Landsides</b>			
	BK099	223122	Landside, rev. R&L
	BK099	279140	Landside, rev. R&L
	BK099	761108	Landside, rev. R&L
	BK098	279138	Skim point R
	BK098	279139	Skim point L
<b>Parts to mount on landsides</b>			
	BK094	63600A	Wearing plate, rev. R&L
	BK094	63601A	Wearing plate, rev. R&L
	BK052	1349408	Sword coulter R
	BK052	1349409	Sword coulter L
	BK096	800MOL	Subsoiler blade R
	BK096	801MOL	Subsoiler blade L

Parts to fit:

# KUHN H4 and H6 ploughbodies

**Bolt box no. Article-no. Designation**

### Mouldboards, shins and accessories

648102 648103		619122 619123		BK069 619122 BK069 619123	Turbo-trashboard R Turbo-trashboard L
612108 612109		619120 619121		BK071 612108 BK071 612109 BK077 619120 BK077 619121	Mouldboard R H4 Mouldboard L H4 Shin R H4 Shin L H4
612110 612111		619128 619129		BK071 612110 BK071 612111 BK077 619128 BK077 619129 BK084 648102 BK084 648103	Mouldboard R H6 Mouldboard L H6 Shin R H6 Shin L H6 Mouldboard extension R Mouldboard extension L

### Shares, points and accessories

622200 (622166) 622201 (622167)		622180 622181	622128 622129	622174 622175	MOL180C MOL181C	BK113 622200 BK113 622201 BK113 622202 Bk113 622203 BK113 622204 Bk113 622205 BK095 622128 BK095 622129 BK095 622174 BK095 622175 BK095 622180 BK095 622181 BK095 MOL180C BK095 MOL181C BK165 MOL202C BK165 MOL203C BK165 MOL204C BK165 MOL205C BK165 MOL202 BK165 MOL203 BK165 MOL204 BK165 MOL205 BK166 MOL25-0 BK166 MOL25-1 MOL83	EUROSHARE 14" H EUROSHARE 14" V EUROSHARE 16" H EUROSHARE 16" V EUROSHARE 18" R EUROSHARE 18" L EUROPOINT Z- R EUROPOINT Z- L EUROPOINT Z-reinforc. R EUROPOINT Z-reinforc. L EUROPOINT rev. R EUROPOINT rev. L EUROCARBIDE M3 point R EUROCARBIDE M3 point L EUROCARBIDESHARE M516" R EUROCARBIDESHARE M516" L EUROCARBIDESHARE M518" R EUROCARBIDESHARE M518" L EUROSHARE M5 16" R EUROSHARE M5 16" L EUROSHARE M5 18" R EUROSHARE M5 18" L M7-Adapter R M7-Adapter L M7 point rev. R/L Wedge for M7 point Wedge for M7 point Share knife R Share knife L
622202 (622172) 622203 (622173)		MOL203C MOL202C	MOL204C MOL205C	MOL202 MOL203	MOL204 MOL205		
622204 622205		270MOL 271MOL	4879058 4879056				

**For KUHN-HUARD Euroshares, please use landsidepoint 223120/223121 and 223120MOL/223121MOL.**

### Landsides

223122		279140		223120 223121	223120MOL 223121MOL	761108		BK097 223120 BK097 223121 BK097 223120MOL BK097 223121MOL BK099 223122 BK099 279140 BK099 761108	Skim point R Skim point L Skim point R Skim point L Landside, rev. R&L Landside, rev. R&L Landside, rev. R&L
--------	--	--------	--	------------------	------------------------	--------	--	--	--

### Parts to mount on landsides

63600A		63601A		1349408 1349409	800MOL 801MOL	BK094 63600A BK094 63601A BK052 1349408 BK052 1349409	Wearing plate, rev. R&L Wearing plate, rev. R&L Sword coulter R Sword coulter L
--------	--	--------	--	--------------------	------------------	--	--

Parts to fit:

# KUHN HB4 and HB6 ploughbodies

		<u>Bolt box no.</u>	<u>Article-no.</u>	<u>Designation</u>
<b>Shins and accessories</b>				
648102 648103				
619120 619121				
619122 619123				
619128 619129				
		BK069	619122	Turbo-trashboard R
		BK069	619123	Turbo-trashboard L
		BK077	619120	Mouldboard R H6
		BK077	619121	Mouldboard L H6
		BK077	619128	Shin R H6
		BK077	619129	Shin L H6
		BK084	648102	Mouldboard extension R
		BK084	648103	Mouldboard extension L
<b>Shares, points and accessories</b>				
622200 (622166) 622201 (622167)				
622202 (622172) 622203 (622173)				
622204 622205				
270MOL 271MOL				
4879058				
4879056				
622180 622181				
622128 622129				
622174 622175				
MOL180C MOL181C				
MOL203C MOL202C				
MOL204C MOL205C				
MOL202 MOL203				
MOL204 MOL205				
MOL25-0 MOL25-1				
MOL83				
		BK113	622200	EUROSHARE 14" H
		BK113	622201	EUROSHARE 14" V
		BK113	622202	EUROSHARE 16" H
		BK113	622203	EUROSHARE 16" V
		BK113	622204	EUROSHARE 18" R
		BK113	622205	EUROSHARE 18" L
		BK095	622128	EUROPOINT Z- R
		BK095	622129	EUROPOINT Z- L
		BK095	622174	EUROPOINT Z-reinforc. R
		BK095	622175	EUROPOINT Z-reinforc. L
		BK095	622180	EUROPOINT rev. R
		BK095	622181	EUROPOINT rev. L
		BK095	MOL180C	EUROCARBIDE M3 point R
		BK095	MOL181C	EUROCARBIDE M3 point L
		BK165	MOL202C	EUROCARBIDESHARE M516" R
		BK165	MOL203C	EUROCARBIDESHARE M516" L
		BK165	MOL204C	EUROCARBIDESHARE M518" R
		BK165	MOL205C	EUROCARBIDESHARE M518" L
		BK165	MOL202	EUROSHARE M5 16" R
		BK165	MOL203	EUROSHARE M5 16" L
		BK165	MOL204	EUROSHARE M5 18" R
		BK165	MOL205	EUROSHARE M5 18" L
		BK166	MOL25-0	M7-Adapter R
		BK166	MOL25-1	M7-Adapter L
			MOL83	M7 point rev. R/L
			4979058	Wedge for M7 point
			4979056	Wedge for M7point
		BK096	270MOL	Share knife R
		BK096	271MOL	Share knife L
<b>For KUHN-HUARD Euroshares, please use landsidepoint 223120/223121 and 223120MOL/223121MOL.</b>				
<b>Landsides</b>				
223122				
279140				
223120 223121				
223120MOL 223121MOL				
761108				
		BK097	223120	Skim point R
		BK097	223121	Skim point L
		BK097	223120MOL	Skim point R
		BK097	223121MOL	Skim point L
		BK099	223122	Landside, rev. R&L
		BK099	279140	Landside, rev. R&L
		BK099	761108	Landside, rev. R&L
<b>Parts to mount on landsides</b>				
63600A				
63601A				
1349408 1349409				
800MOL 801MOL				
		BK094	63600A	Wearing plate, rev. R&L
		BK094	63601A	Wearing plate, rev. R&L
		BK052	1349408	Sword coulter R
		BK052	1349409	Sword coulter L
		BK096	800MOL	Subsoiler blade R
		BK096	801MOL	Subsoiler blade L

Parts to fit:

# KUHN SK ploughbody

**Mouldboard and shin**

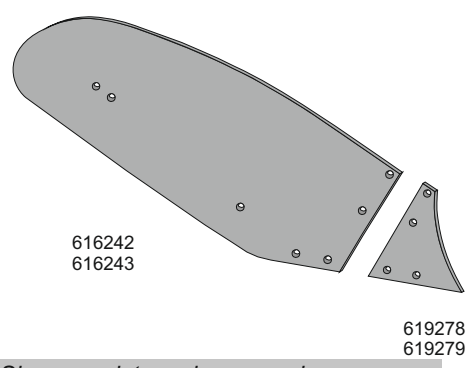

Bolt box no.	Article-no.	Designation
BK071	616242	Mouldboard R
BK071	616243	Mouldboard L
BK150	619278	Shin R
BK150	619279	Shin L

**Shares, points and accessories**

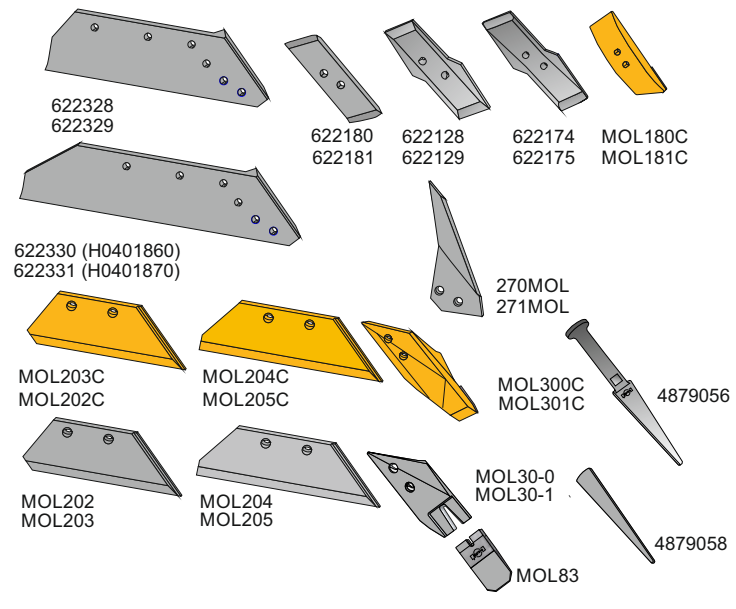

BK095	622180	EUROPOINT rev. R
BK095	622181	EUROPOINT rev. L
BK095	MOL180C	EUROCARBIDE M3 point R
BK095	MOL181C	EUROCARBIDE M3 point L
BK095	622128	EUROPOINT Z- R
BK095	622129	EUROPOINT Z- L
BK095	622174	EUROPOINT Z- reforc. R
BK095	622175	EUROPOINT Z- reforc. L
BK113	622328	Share f/rev. point 14" R
BK113	622329	Share f/rev. point 14" L
BK113	622330	Share f/rev. point 16" R
BK113	622331	Share f/rev. point 16" L
BK165	MOL202C	EUROCARBIDESHARE M516" R
BK165	MOL203C	EUROCARBIDESHARE M5 16" L
BK165	MOL204C	EUROCARBIDESHARE M518" R
BK165	MOL205C	EUROCARBIDESHARE M5 18" L
BK166	MOL202	EUROSHARE M5 16" R
BK166	MOL203	EUROSHARE M5 16" L
BK166	MOL204	EUROSHARE M5 18" R
BK166	MOL205	EUROSHARE M5 18" L
	MOL30-0	M7-Adapter R
	MOL30-1	M7-Adapter L
	MOL83	M7 point rev. R/L
	4879058	Wedge for M7 point
	4879056	Wedge for M7 point
BK166	MOL300C	EUROCARBIDE M5 point R
BK166	MOL301C	EUROCARBIDE M5 point L
BK096	270MOL	Share knife R
BK096	271MOL	Share knife L

**For KUHN-HUARD Euroshares, please use landsidepoint MOL761216 / MOL761217.**

**Landsides**

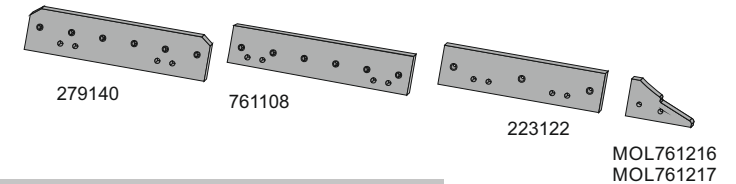

	279140	Landside, rev. R&L
	761108	Landside, rev. R&L
	MOL761216	Skim point R
	MOL761217	Skim point L
	223122	Landside, rev. R&L

**Parts to mount on landsides**

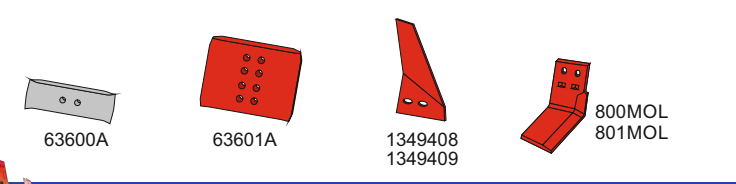

BK099	63600A	Wearing plate, rev. R&L
BK099	63601A	Wearing plate, rev. R&L
BK097	1349408	Sword coulter R
BK097	1349409	Sword coulter L
BK099	800MOL	Subsoiler blade R
BK099	801MOL	Subsoiler blade L

Parts to fit:

# KUHN VL ploughbody

**Bolt box no. Article-no. Designation**

## Shin

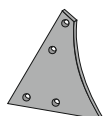

H0403520  
H0403530

BK150 H0403520 Shin R  
BK150 H0403530 Shin L

## Shares, points and accessories

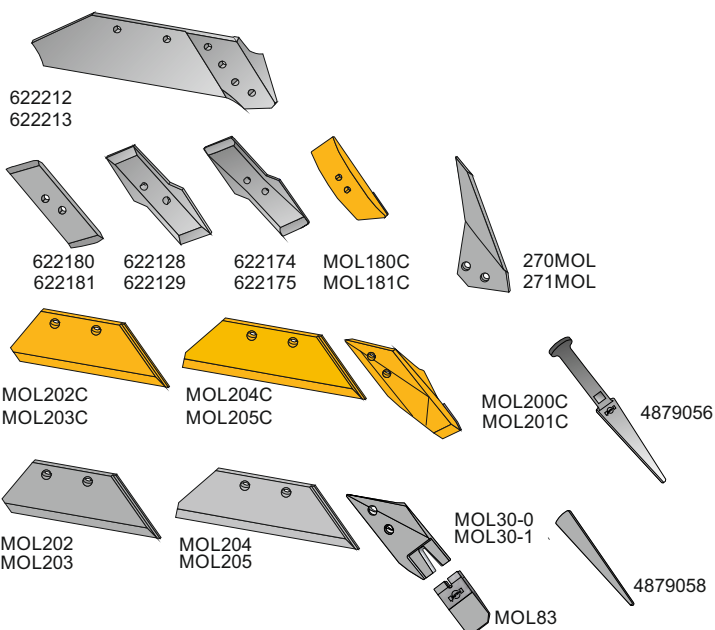

BK095 622180 EUROPOINT rev. R  
BK095 622181 EUROPOINT rev. L  
BK095 MOL180C EUROCARBIDE M3 point R  
BK095 MOL181C EUROCARBIDE M3 point L  
622128 EUROPOINT Z- R  
BK095 622129 EUROPOINT Z- L  
BK095 622174 EUROPOINT Z- reinforc. R  
BK095 622175 EUROPOINT Z- reinforc. L  
BK166 MOL200C EUROCARBIDE M5 point R  
BK166 MOL201C EUROCARBIDE M5 point L  
622213 Share f/rev. point 16" R  
BK113 622212 Share f/rev. point 16" L  
BK165 MOL202C EUROCARBIDESHARE M5 16" R  
BK165 MOL203C EUROCARBIDESHARE M5 16" L  
BK165 MOL204C EUROCARBIDESHARE M5 18" R  
BK165 MOL205C EUROCARBIDESHARE M5 18" L  
BK165 MOL202 EUROSHARE M5 16" R  
BK165 MOL203 EUROSHARE M5 16" L  
BK165 MOL204 EUROSHARE M5 18" R  
BK165 MOL205 EUROSHARE M5 18" L  
BK166 MOL20-0 M7-Adpter R  
BK166 MOL20-1 M7-Adpter R  
MOL83 M7 point rev. R/L  
4879058 Wedge for M7 point  
4879056 Wedge for M7 point  
BK096 270MOL Share knife R  
BK096 271MOL Share knife L

## Landsides

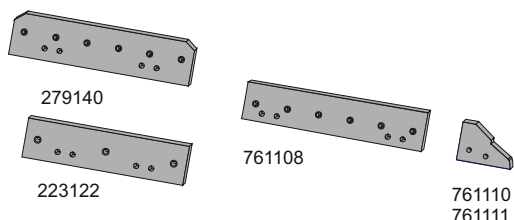

BK099 279140 Landside, rev. R&L  
BK099 223122 Landside, rev. R&L  
BK099 761108 Landside, rev. R&L  
Bk098 761110 Skim point R  
BK098 761111 Skim point L

## Parts to mount on landsides

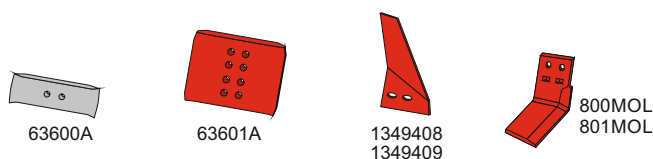

BK094 63600A Wearing plate, rev. R&L  
BK094 63601A Wearing plate, rev. R&L  
BK052 1349408 Sword coulter R  
BK052 1349409 Sword coulter L  
BK096 800MOL Subsoiler blade R  
BK096 801MOL Subsoiler blade L



Parts to fit:

## KUHN VS/N ploughbodies

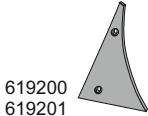
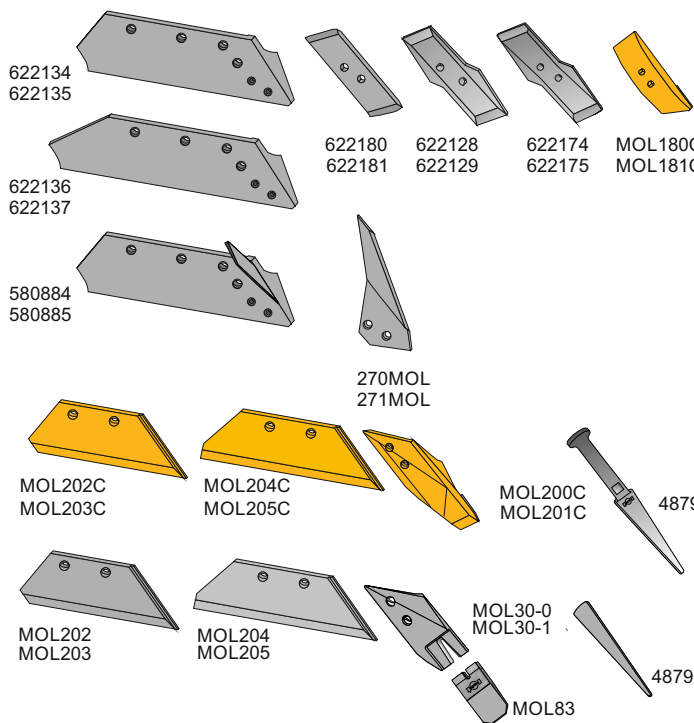
	<b>Bolt box no.</b>	<b>Article-no.</b>	<b>Designation</b>
<b>Shin</b>			
 619200 619201	BK052	619200	Shin R
	BK052	619201	Shin L
<b>Shares, points and accessories</b>			
 622134 622135  622136 622137  580884 580885  270MOL 271MOL  MOL202C MOL203C MOL204C MOL205C  MOL202 MOL203 MOL204 MOL205  MOL200C MOL201C 4879056  MOL30-0 MOL30-1 MOL83 4879058  270MOL 271MOL  MOL180C MOL181C	BK095	622180	EUROPOINT rev. R
	BK095	622181	EUROPOINT rev. L
	BK095	MOL180C	EUROCARBIDE M3 point R
	BK095	MOL181C	EUROCARBIDE M3 point L
	BK095	622128	EUROPOINT Z- R
	BK095	622129	EUROPOINT Z- L
	BK095	622174	EUROPOINT Z- reinforc. R
	BK095	622175	EUROPOINT Z- reinforc. L
	BK166	MOL200C	EUROCARBIDE M5 point R
	BK166	MOL201C	EUROCARBIDE M5 point L
	BK113	622134	EUROSHARE 14" R
	BK113	622135	EUROSHARE 14" L
	BK113	622136	EUROSHARE 16" R
	BK113	622137	EUROSHARE 16" L
	BK113	580884	EUROSHARE 14" R
	BK113	580885	EUROSHARE 14" L
	BK165	MOL202C	EUROCARBIDESHARE M516" R
	BK165	MOL203C	EUROCARBIDESHARE M516" L
	BK165	MOL204C	EUROCARBIDESHARE M518" R
	BK165	MOL205C	EUROCARBIDESHARE M518" L
	BK165	MOL202	EUROSHARE M5 16" R
	BK165	MOL203	EUROSHARE M5 16" L
	BK165	MOL204	EUROSHARE M5 18" R
	BK165	MOL205	EUROSHARE M5 18" L
	BK166	MOL20-0	M7-Adpter R
	BK166	MOL20-1	M7-Adpter R
		MOL83	M7 point rev. R/L
	4879058	Wedge for M7 point	
	4879056	Wedge for M7point	
BK096	270MOL	Share knife R	
BK096	271MOL	Share knife L	

<b>Landside</b>			
 278074 278075	BK077	278074	Landside, short R
	BK077	278075	Landside, short L
 278076 278077	BK072	278076	Landside, long R
	BK072	278077	Landside, long L

Parts to fit:

## KUHN plough

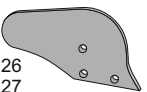
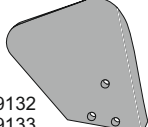
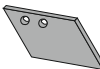
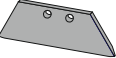
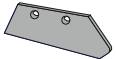



	<b>Bolt box no.</b>	<b>Article-no.</b>	<b>Designation</b>
<b>Skim shares and skim mouldboards</b>			
 619126 619127	BK058	619126	Skim mouldboard R
	BK058	619127	Skim mouldboard L
 619132 619133	BK058	619132	Skim mouldboard R
	BK058	619133	Skim mouldboard L
 631100 631101	BK052	631100	Skim share R
	BK052	631101	Skim share L
 631104 631105	BK052	631102	Skim share R
	BK052	631103	Skim share L
 631102 631103	BK052	631104	Skim share R
	BK052	631104	Skim share R

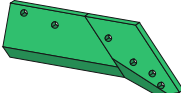

Parts to fit:

## KVERNELAND ploughbody serie 53

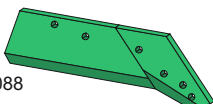

### Shares, point and accessories

		<b>Bolt box no.</b>	<b>Article-no.</b>	<b>Designation</b>
53087		BK095	73091	Share knife R
		BK094	53090	EUROPOINT rev. R
		BK095	5309MOLC	EUROCARBIDE M3 point R
			73091	
53088		BK100	53087	EUROSHARE f/rev.point 14" R
		BK100	53088	EUROSHARE f/rev.point 16" R

### Landsides

53684		BK118	53684	Landside, short R
-------	---	-------	-------	-------------------

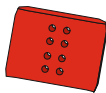

### Parts to mount on landsides

63600A		BK094	63600A	Wearing plate, rev. R&L
63601A		BK094	63601A	Wearing plate, rev. R&L
1349408		BK052	1349408	Sword coulter R
800MOL		Bk096	800MOL	Subsoiler blade R





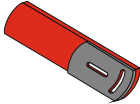
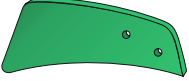

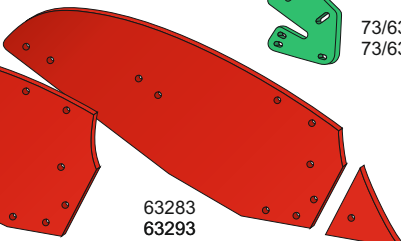
Parts to fit:

## KVERNELAND ploughbody no. 1 and 3

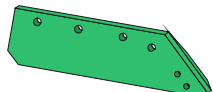
### Mouldboards, shins and accessories

53387		BK167	73/63-300	Turbo-trashboard R
63388		BK167	73/63-301	Turbo-trashboard L
			73/63-310	Fittings for trashboard R
			73/63-311	Fittings for trashboard L
		BK082	53387	Mouldboard extension R
		BK082	63388	Mouldboard extension L
		Bk056	63283	Mouldboard R
		BK056	63293	Mouldboard L
		BK056	63261	Mouldboard R
		BK056	63271	Mouldboard L
63261		BK053	63240	Shin R
63271		BK053	63250	Shin L
63283			63240	
63293			63250	

### Shares, points and accessories

063014		BK100	063014	EUROSHARE 14" R
063017		BK100	063017	EUROSHARE 14" L
		BK100	063015	EUROSHARE 16" R
		BK100	063018	EUROSHARE 16" L
		BK096	73091	Share knife R
		BK096	73092	Share knife L
		BK094	53090	EUROPOINT Rev. R
		BK094	63090	EUROPOINT Rev. L
		BK095	5309MOLC	EUROCARBIDE M3 point R
		BK095	6309MOLC	EUROCARBIDE M3 point L



Parts to fit:

## KVERNELAND ploughbody no. 1 and 3

Landsides		Bolt box no.	Article-no.	Designation
63610		BK128	63610	Landside, short R&L
		BK103	63615	Landside, short, low R
		BK103	63606	Landside, short, low L
		BK103	63613	Landside, long, low R
		BK103	63604	Landside, long, low L
63601		BK118	63602	Landside, short R
		BK118	63601	Landside, long R
63615		BK103	63605	Landside, short, low R
63606		BK103	63603	Landside, long, low R
		BK136	63607	Conversion plate R
			63608	Conversion plate f/rev.plough R
			63609	Conversion plate f/rev.plough L
63613				
63604				

### Parts to mount on landsides

	63600A	BK094	63600A	Wearing plate, rev. R&L
	63601A	BK094	63601A	Wearing plate, rev. R&L
	1349408	BK052	1349408	Sword coulter R
	1349409	BK052	1349409	Sword coulter L
	800MOL	BK096	800MOL	Subsoiler blade R
	801MOL	BK096	801MOL	Subsoiler blade L

Parts to fit:

## KVERNELAND ploughbody no. 8 and 9

### Mouldboards, shins and accessories

	73/63-300	BK167	73/63-300	Turbo-trashboard R
	73/63-301	BK167	73/63-301	Turbo-trashboard L
	73/63-310		73/63-310	Fittings for trashboard R
	73/63-311		73/63-311	Fittings for trashboard L
	073801 for 73406/7	BK156	073801	Brace R&L (for frog 73406/7)
	73803 for 73411/12	BK156	73803	Brace R&L (for frog 73411/12)
	73800	BK113	73800	Brace fitting R
	73801	BK113	73801	Brace fitting L
	53387	BK082	53387	Mouldboard extension R
	63388	BK082	63388	Mouldboard extension L
	73290	BK059	73290	Mouldboard R no.9 14"-20"
	73291	BK059	73291	Mouldboard L no.9 14"-20"
	73286	BK056	73286	Mouldboard R no.8 14"-20"
	73287	BK056	73287	Mouldboard L no.8 14"-20"
	73280	BK056	73280	Mouldboard R no.8 12"
	73281	BK056	73281	Mouldboard L no.8 12"
	73256	BK058	73256	Shin R
	73257	BK058	73257	Shin L
	73250	BK052	73250	Shin R
	73251	BK052	73251	Shin L
	73266		73266	Bracket for shin R
	73267		73267	Bracket for shin L
	73411		73411	Frog R
	73412		73412	Frog L
	73406		73406	Frog R
	73407		73407	Frog L

**Did you know...**

that you can wear out more than

six points before you have to replace the M7-adapter.





Parts to fit:

# KVERNELAND ploughbody no. 8 and 9

Shares, points and accessories		Bolt box no.	Article-no.	Designation
073002		BK113	073002	EUROSHARE 14" R
073003		BK113	073003	EUROSHARE 14" L
073004		BK113	073004	EUROSHARE 16" R
073005		BK113	073005	EUROSHARE 16" L
073004-14			073004-14	EUROSHARE 16" R 14mm
073005-14		073005-14	EUROSHARE 16" L 14mm	
073006		BK114	073006	EUROSHARE 18" R
073007		BK114	073007	EUROSHARE 18" L
073008		BK114	073008	EUROSHARE 20" R
073009		BK114	073009	EUROSHARE 20" L
MOL83018C		BK170	83018	EUROSHARE M5 16" R
MOL83019C		BK170	83019	EUROSHARE M5 16" L
MOL83020C		BK170	83020	EUROSHARE M5 18" R
MOL83021C		BK170	83021	EUROSHARE M5 18" L
83018		BK170	83022	EUROSHARE M5 20" R
83019		BK170	83023	EUROSHARE M5 20" L
83020		BK111	83010C	EUROCARBIDE M5 point R
83021		BK111	83011C	EUROCARBIDE M5 point L
83022		BK111	MOL83-0	M7-adaptor R
83023		BK111	MOL83-1	M7-adaptor L
			MOL83	M7 point rev. R/L
				4879058
			4879056	Wedge for M7 point
				73091
			73092	Share knife L
				53090
			63090	EUROPOINT Rev. L
				5309MOLC
			6309MOLC	EUROCARBIDE M3 point L
				73414
			73415	Bracket for 18" and 20" shares L
				MOL83018C
			MOL83019C	EUROCARBIDESHARE M5 16" L
				MOL83020C
			MOL83021C	EUROCARBIDESHARE M5 18" L

Landsides and share knives		Bolt box no.	Article-no.	Designation
73608		BK111	73608	Landside, short R&L
73609		BK111	73609	Landside, long R&L
73088		BK110	73088	Share knife R
73089		BK110	73089	Share knife L
84320		BK110	84320	Share knife R
84321		BK110	84321	Share knife L
73608C		BK111	73608C	Landside, coated short R&L
73609C		BK111	73609C	Landside, coated long R&L
84320			84320	
84321			84321	

Parts to mount on landsides		Bolt box no.	Article-no.	Designation
63600A		BK094	63600A	Wearing plate, rev. R&L
63601A		BK094	63601A	Wearing plate, rev. R&L
1349408		BK052	1349408	Sword coulters R
1349409		BK052	1349409	Sword coulters L
800MOL		BK096	800MOL	Subsoiler blade R
801MOL		BK096	801MOL	Subsoiler blade L

Parts to fit:

# KVERNELAND ploughbody no. 14

Mouldboards, shins and accessories		Bolt box no.	Article-no.	Designation
	73800	BK113	73800	Brace fitting R
	73801	BK113	73801	Brace fitting L
	73278	BK156	73829	Brace R&L
	73279		73350	Turbo-trashboard R
			73351	Turbo-trashboard L
			73348	Shin plastic R
			73349	Shin plastic L
			73278	Mouldboard plastic R
			73279	Mouldboard plastic L

Shares, points and accessories		Bolt box no.	Article-no.	Designation
	073054	BK113	073054	EUROSHARE 14" R
	073055	BK113	073055	EUROSHARE 14" L
	073056	BK113	073056	EUROSHARE 16" R
	073057	BK113	073057	EUROSHARE 16" L
	073080	BK113	073080	EUROSHARE 18" R
	073081	BK113	073081	EUROSHARE 18" L
	MOL83018C	BK096	73091	Share knife R
	MOL83019C	BK096	73092	Share knife L
	MOL83020C	BK094	53090	EUROPOINT Rev. R
	MOL83021C	BK094	63090	EUROPOINT Rev. L
	83018	BK095	5309MOLC	EUROCARBIDE M3 point R
	83019	BK095	6309MOLC	EUROCARBIDE M3 point L
	83020	BK170	83018	EUROSHARE M5 16" R
	83021	BK170	83019	EUROSHARE M5 16" L
		BK170	83020	EUROSHARE M5 18" R
		BK170	83021	EUROSHARE M5 18" L
		BK111	83012C	EUROCARBIDE M5 point R
		BK111	83013C	EUROCARBIDE M5 point L
		BK111	MOL83-2	M7 point rev. R/L
		BK111	MOL83-3	M7-adaptor R
		MOL83	M7-adaptor L	
		4879058	Wedge for M7 point	
		4879056	Wedge for M7 point	
	BK170	MOL83018C	EUROCARBIDESHARE M5 16" R	
	BK170	MOL83019C	EUROCARBIDESHARE M5 16" L	
	BK170	MOL83020C	EUROCARBIDESHARE M5 18" R	
	BK170	MOL83021C	EUROCARBIDESHARE M5 18" L	

Landsides and share knives		Bolt box no.	Article-no.	Designation
	73608	BK111	73608	Landside, short R&L
	73609	BK111	73609	Landside, long R&L
	73088	BK110	73088	Share knife R
	73089	BK110	73089	Share knife L
	84320	BK110	84320	Share knife R
	84321	BK110	84321	Share knife L
	73608C	BK111	73608C	Landside, coated short R&L
	73609C	BK111	73609C	Landside, coated long R&L

Parts to mount on landsides		Bolt box no.	Article-no.	Designation
	63600A	BK094	63600A	Wearing plate, rev. R&L
	63601A	BK094	63601A	Wearing plate, rev. R&L
	1349408	BK052	1349408	Sword coulter R
	1349409	BK052	1349409	Sword coulter L
	800MOL	BK096	800MOL	Subsoiler blade R
	801MOL	BK096	801MOL	Subsoiler blade L

Parts to fit:

# KVERNELAND ploughbody no. 28

Mouldboards, shins and accessories		Bolt box no.	Article-no.	Designation
73800 73801		BK167	73/63-300	Turbo-trashboard R
		BK167	73/63-301	Turbo-trashboard L
			73/63-310	Fittings for trashboard R
			73/63-311	Fittings for trashboard L
53387 63388		BK156	073803	Brace R&L (for frog 73411/12)
		BK156	073831	Brace R&L (for frog 73406/7)
		BK156	083810	Brace R&L (for frog 73406/7)
		BK113	73800	Brace fitting R
		BK113	73801	Brace fitting L
		BK082	53387	Mouldboard extension R
		BK082	63388	Mouldboard extension L
83228 83229		BK154	83228	Mouldboard R no.28 14"-20"
		BK154	83229	Mouldboard L no.28 14"-20"
		BK052	73250	Shin R
		BK052	73251	Shin L
			73266	Bracket for shin R
			73267	Bracket for shin L
			73411	Frog R
			73412	Frog L
			73406	Frog R
			73407	Frog L

Shares, points and accessories		Bolt box no.	Article-no.	Designation
073002 073003		BK113	073002	EUROSHARE 14" R
		BK113	073003	EUROSHARE 14" L
073004 073005		BK113	073004	EUROSHARE 16" R
		BK113	073005	EUROSHARE 16" L
073004-14 073005-14			073004-14	EUROSHARE 16" R 14mm
			073005-14	EUROSHARE 16" L 14mm
073006 073007		BK114	073006	EUROSHARE 18" R
		BK114	073007	EUROSHARE 18" L
073008 073009		BK114	073008	EUROSHARE 20" R
		BK114	073009	EUROSHARE 20" L
83018 83019		BK170	83018	EUROSHARE M5 16" R
		BK170	83019	EUROSHARE M5 16" L
83020 83021		BK170	83020	EUROSHARE M5 18" R
		BK170	83021	EUROSHARE M5 18" L
83022 83023		BK170	83022	EUROSHARE M5 20" R
		BK170	83023	EUROSHARE M5 20" L
		BK111	83010C	EUROCARBIDE M5 point R
		BK111	83011C	EUROCARBIDE M5 point L
		BK111	MOL83-0	M7-adaptor R
		BK111	MOL83-1	M7-adaptor L
			MOL83	M7 point rev. R/L
			4879058	Wedge for M7 point
			4879056	Wedge for M7 point
		BK095	73091	Share knife R
		BK095	73092	Share knife L
		BK094	53090	EUROPOINT Rev. R
		BK094	63090	EUROPOINT Rev. L
		BK095	5309MOLC	EUROCARBIDE M3 point R
		BK095	6309MOLC	EUROCARBIDE M3 point L
			73414	Bracket for 18" and 20" shares R
			73415	Bracket for 18" and 20" shares L
		BK170	MOL83018C	EUROCARBIDESHARE M5 16" R
		BK170	MOL83019C	EUROCARBIDESHARE M5 16" L
		BK170	MOL83020C	EUROCARBIDESHARE M5 18" R
		BK170	MOL83021C	EUROCARBIDESHARE M5 18" L

Parts to fit:

## KVERNELAND ploughbody no. 28

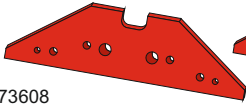
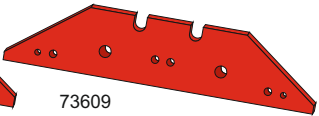
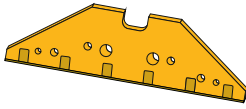
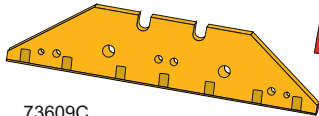
Landsides and share knives		<u>Bolt box no.</u>	<u>Article-no.</u>	<u>Designation</u>
		BK111	73608	Landside, short R&L
73608	73609	BK111	73609	Landside, long R&L
		BK110	73088	Share knife R
		BK110	73089	Share knife L
		BK110	84320	Share knife R
		BK110	84321	Share knife L
		BK111	73608C	Landside, coated short R&L
		BK111	73609C	Landside, coated long R&L
73608C	73609C		84320	
			84321	

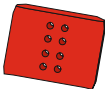
Redskaber til montering på landsiden				
		BK094	63600A	Wearing plate, rev. R&L
63600A	63601A	BK094	63601A	Wearing plate, rev. R&L
		BK052	1349408	Sword coulter R
		BK052	1349409	Sword coulter L
		BK096	800MOL	Subsoiler blade R
		BK096	801MOL	Subsoiler blade L
			800MOL	
			801MOL	

### **Did you know...**

*that Mølbros landsides are longer than original landsides. This feature gives your plough much more stability while ploughing which makes it easier to control the plough.*

### **Did you know...**

*that the upset forged front of the share gives an extra support for the reversible point or EUROPOINT and is designed to ensure that it is easy to get the plough into the soil.*

Parts to fit:

## KVERNELAND ploughbodies no. 12 and 19

	<u>Bolt box no.</u>	<u>Article-no.</u>	<u>Designation</u>
<b>Mouldboards, shins and accessories</b>			
	BK167	73/63-300	Turbo-trashboard R
	BK167	73/63-301	Turbo-trashboard L
		73/63-310	Fittings for trashboard R
		73/63-311	Fittings for trashboard L
	BK082	53387	Mouldboard extension R
	BK082	63388	Mouldboard extension L
	BK059	73290	Mouldboard R
	BK059	73291	Mouldboard L
	BK113	73800	Brace fitting R
	BK113	73801	Brace fitting L
	BK156	73805	Brace R&L (for frog 73406/7)
	BK058	73230	Shin R
	BK058	73231	Shin L
	BK058	73241	Shin R
	BK058	73242	Shin L
		73266	Bracket for shin R
		73267	Bracket for shin L
		73435	Frog R
		73436	Frog L
<b>Shares, points and accessories</b>			
	BK113	073054	EUROSHARE 14" R
	BK113	073055	EUROSHARE 14" L
	BK113	073056	EUROSHARE 16" R
	BK113	073057	EUROSHARE 16" L
	BK113	073080	EUROSHARE 18" R
	BK113	073081	EUROSHARE 18" L
	BK113	073084	EUROSHARE 20" R
	BK113	073085	EUROSHARE 20" L
	BK096	73091	Share knife R
	BK096	73092	Share knife L
	BK094	53090	EUROPOINT Rev. R
	BK094	63090	EUROPOINT Rev. L
	BK095	5309MOLC	EUROCARBIDE M3 point R
	BK095	6309MOLC	EUROCARBIDE M3 point L
	BK170	83018	EUROSHARE M5 16" R
	BK170	83019	EUROSHARE M5 16" L
	BK170	83020	EUROSHARE M5 18" R
	BK170	83021	EUROSHARE M5 18" L
	BK170	83022	EUROSHARE M5 20" R
	BK170	83023	EUROSHARE M5 20" L
	BK111	83012C	EUROCARBIDE M5 point R
	BK111	83013C	EUROCARBIDE M5 point L
	BK111	MOL83-2	M7-adapter R
	BK111	MOL83-3	M7-adapter L
		MOL83	M7 point rev. R/L
		4879058	Wedge for M7 point
		4879056	Wedge for M7 point
	BK170	MOL83018C	EUROCARBIDESHARE M5 16" R
	BK170	MOL83019C	EUROCARBIDESHARE M5 16" L
	BK170	MOL83020C	EUROCARBIDESHARE M5 18" R
	BK170	MOL83021C	EUROCARBIDESHARE M5 18" L





### Did you know...

that the special hole shape of the point for EUROSHARE makes it possible to mount it with a unique high headed bolt which allow the point to be worn even thinner?

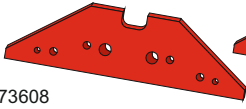
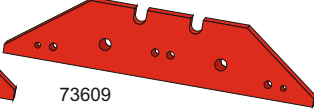
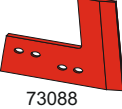
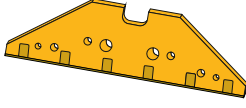
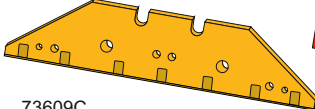
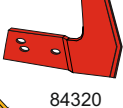
Parts to fit:

## KVERNELAND ploughbodies no. 12 and 19

		<u>Bolt box no.</u>	<u>Article-no.</u>	<u>Designation</u>
<b>Landsides and share knives</b>				
			BK111 73608 BK111 73609 BK110 73088 Bk110 73089 BK110 84320 BK110 84321	Landside, short R&L Landside, long R&L Share knife R Share knife L Share knife R Share knife L
73608	73609	73088 73089		
			BK111 73608C BK111 73609C	Landside, coated short R&L Landside, coated long R&L
73608C	73609C	84320 84321		

<b>Parts to mount on landsides</b>				
				BK094 63600A BK094 63601A BK052 1349408 BK052 1349409 BK096 800MOL BK096 801MOL
63600A	63601A	1349408 1349409	800MOL 801MOL	Wearing plate, rev. R&L Wearing plate, rev. R&L Sword coulter R Sword coulter L Subsoiler blade R Subsoiler blade L

Parts to fit:

# KVERNELAND ploughbodies no. 20 and 30

**Bolt box no. Article-no. Designation**

## Mouldboards, shins and accessories

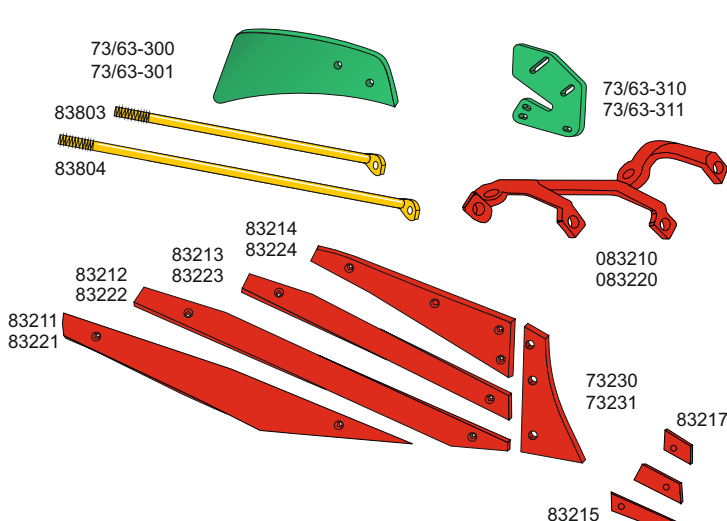

BK167	73/63-300	Turbo-trashboard R
BK167	73/63-301	Turbo-trashboard L
	73/63-310	Fittings for trashboard R
	73/63-311	Fittings for trashboard L
	83803	Brace R&L
	83804	Brace R&L
	083210	Stay with support R
	083220	Stay with support L
	83211	Mouldboard stripe R
	83221	Mouldboard stripe L
	83212	Mouldboard stripe R
	83222	Mouldboard stripe L
	83213	Mouldboard stripe R
	83223	Mouldboard stripe L
	83214	Mouldboard stripe R
	83224	Mouldboard stripe L
	73230	Shin R
BK058	73231	Shin L
	83217	Bracket for mouldboard
	83216	Bracket for mouldboard
	83215	Bracket for mouldboard

## Shares, points and accessories

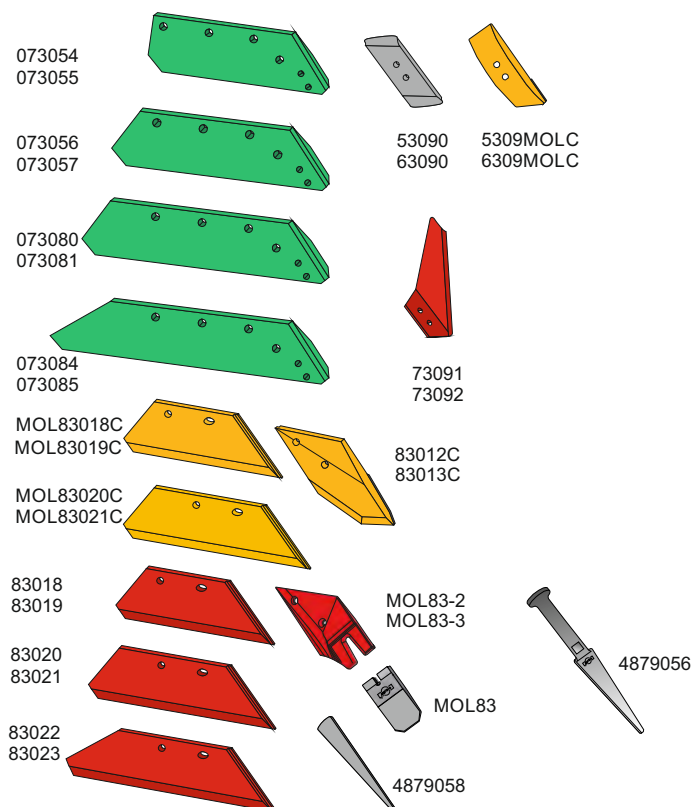

BK113	073054	EUROSHARE 14" R
BK113	073055	EUROSHARE 14" L
BK113	073056	EUROSHARE 16" R
BK113	073057	EUROSHARE 16" L
BK113	073080	EUROSHARE 18" R
BK113	073081	EUROSHARE 18" L
BK113	073084	EUROSHARE 20" R
BK113	073085	EUROSHARE 20" L
BK095	73091	Share knife R
BK095	73092	Share knife L
BK094	53090	EUROPOINT Rev. R
BK094	63090	EUROPOINT Rev. L
BK095	5309MOLC	EUROCARBIDE M3 point R
BK095	6309MOLC	EUROCARBIDE M3 point L
BK170	83018	EUROSHARE M5 16" R
BK170	83019	EUROSHARE M5 16" L
BK170	83020	EUROSHARE M5 18" R
BK170	83021	EUROSHARE M5 18" L
BK170	83022	EUROSHARE M5 20" R
BK170	83023	EUROSHARE M5 20" L
BK111	83012C	EUROCARBIDE M5 point R
BK111	83013C	EUROCARBIDE M5 point L
BK111	MOL83-2	M7-adaptor R
BK111	MOL83-3	M7-adaptor L
	MOL83	M7 point rev. R/L
	4879058	Wedge for M7 point
	4879056	Wedge for M7 point
BK170	MOL83018C	EUROCARBIDESHARE M5 16" R
BK170	MOL83019C	EUROCARBIDESHARE M5 16" L
BK170	MOL83020C	EUROCARBIDESHARE M5 18" R
BK170	MOL83021C	EUROCARBIDESHARE M5 18" L





**Did you know...**

that you will reduce mounting time by using Mølbros M5 system as the carbide coated EUROCARBID M5 point will last just as long as the share.

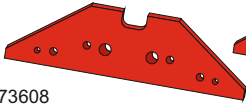
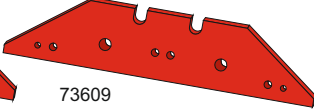
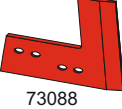
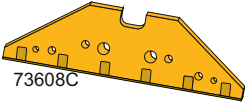
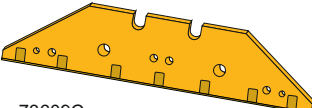
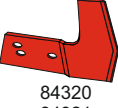

Parts to fit:

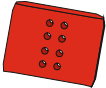
## KVERNELAND ploughbodies no. 20 and 30

		<u>Bolt box no.</u>	<u>Article-no.</u>	<u>Designation</u>
<b>Landsides and share knives</b>				
			BK111 73608 BK111 73609 BK110 73088 BK110 73089 BK110 84320 BK110 84321	Landside, short R&L Landside, long R&L Share knife R Share knife L Share knife R Share knife L
73608	73609	73088 73089		
			BK111 73608C BK111 73609C	Landside, coated short R&L Landside, coated long R&L
73608C	73609C	84320 84321		
<b>Parts to mount on landsides</b>				
				63600A Wearing plate, rev. R&L 63601A Wearing plate, rev. R&L 1349408 Sword coulter R 1349409 Sword coulter L 800MOL Subsoiler blade R 801MOL Subsoiler blade L
63600A	63601A	1349408 1349409	800MOL 801MOL	



Parts to fit:

# KVERNELAND ploughbody ECOMAT

**Bolt box no. Article-no. Designation**

## Mouldboard

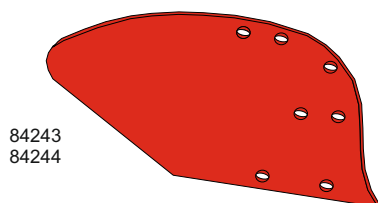

84243 Mouldboard 14"-20" R  
84244 Mouldboard 14"-20" L

## Shares, points and accessories

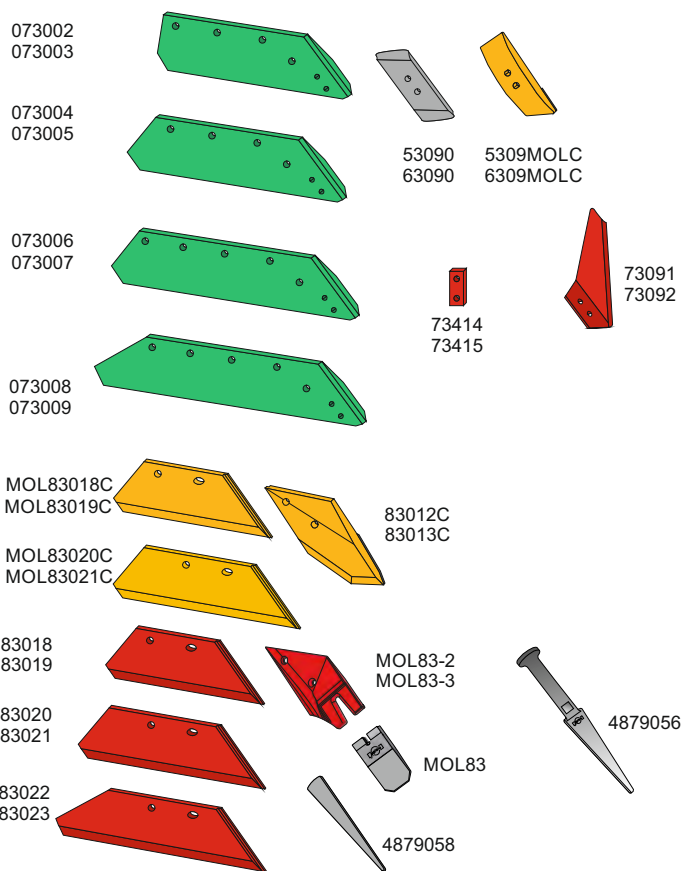

<i>BK113</i>	073002	EUROSHARE 14" R
<i>BK113</i>	073003	EUROSHARE 14" L
<i>BK113</i>	073004	EUROSHARE 16" R
<i>BK113</i>	073005	EUROSHARE 16" L
<i>BK114</i>	073006	EUROSHARE 18" R
<i>BK114</i>	073007	EUROSHARE 18" L
<i>BK114</i>	073008	EUROSHARE 20" R
<i>BK114</i>	073009	EUROSHARE 20" L
<i>BK170</i>	83018	EUROSHARE M5 16" R
<i>BK170</i>	83019	EUROSHARE M5 16" L
<i>BK170</i>	83020	EUROSHARE M5 18" R
<i>BK170</i>	83021	EUROSHARE M5 18" L
<i>BK170</i>	83022	EUROSHARE M5 20" R
<i>BK170</i>	83023	EUROSHARE M5 20" L
<i>BK111</i>	83010C	EUROCARBIDE M5 point R
<i>BK111</i>	83011C	EUROCARBIDE M5 point L
<i>BK111</i>	MOL83-0	M7-adapter R
<i>BK111</i>	MOL83-1	M7-adapter L
	MOL83	M7 point rev. R/L
	4879058	Wedge for M7 point
	4879056	Wedge for M7 point
<i>BK095</i>	73091	Share knife R
<i>BK095</i>	73092	Share knife L
<i>BK094</i>	53090	EUROPOINT Rev. R
<i>BK094</i>	63090	EUROPOINT Rev. L
<i>BK095</i>	5309MOLC	EUROCARBIDE M3 point R
<i>BK095</i>	6309MOLC	EUROCARBIDE M3 point L
	73414	Bracket for 18" and 20" shares R
	73415	Bracket for 18" and 20" shares L
<i>BK170</i>	MOL83018C	EUROCARBIDESHARE M5 16" R
<i>BK170</i>	MOL83019C	EUROCARBIDESHARE M5 16" L
<i>BK170</i>	MOL83020C	EUROCARBIDESHARE M5 18" R
<i>BK170</i>	MOL83021C	EUROCARBIDESHARE M5 18" L

## Landsides and share knives

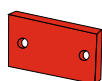

84234

84234 Landside, short R&L

Parts to fit:

# KVERNELAND ploughs

**Bolt box no. Article-no. Designation**

*Skim shares, skim mouldboards and accesories*

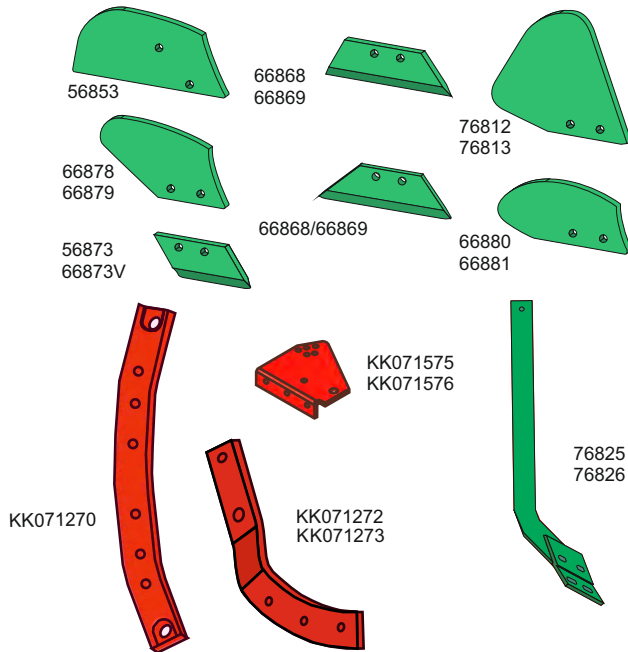

BK026	56853	Skim mouldboard R
BK026	66878	Skim mouldboard R
BK026	66879	Skim mouldboard L
BK026	76812	Skim mouldboard R
BK026	76813	Skim mouldboard L
BK026	66880	Skim mouldboard R
BK026	66881	Skim mouldboard L
BK004	56873	Skim share, short R
BK004	66873V	Skim share, short L
BK004	66868	Skim share, long R
BK004	66869	Skim share, long L
BK004	66868/66869	Skim share, R&L
	76825	Beam R 800mm
	76826	Beam L 800mm
	KK071575	Adapter plade beam bottom
	KK071576	Adapter plade beam top
	KK071270	Beam 800mm center
	KK071272	Beam R
	KK071273	Beam L

*Disc coulters and accessories*

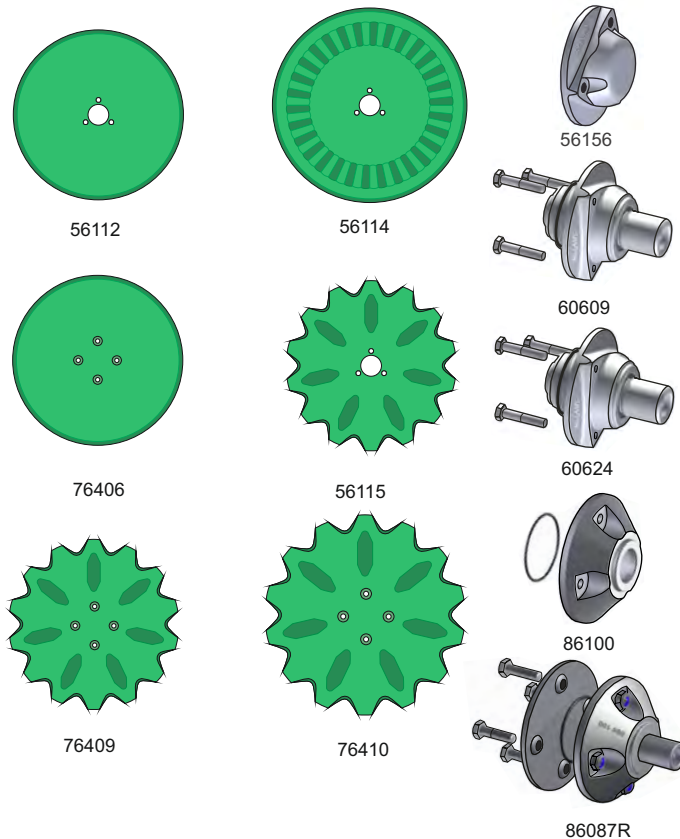

	56112	Disc coultter, 18"
	56114	Disc coultter, rippled 20"
	56115	Disc coultter, notched 18"
	76406	Disc coultter 18"
	76409	Disc coultter 18"
	76410	Disc coultter 20"
	56156	Universal cover for hub
	60609	Hub disc coultter Ø34mm
	60624	Hub disc coultter Ø30mm
	86100	Hub for disc coultter
	86087R	Hub disc coultter

Parts to fit:

# LEMKEN B ploughbody

		<u>Bolt box no.</u>	<u>Article-no.</u>	<u>Designation</u>
<b>Mouldboards, shins and accessories</b>				
		BK009	3470860	Turbo-trashboard R
		BK009	3470861	Turbo-trashboard L
		BK013	3476000	Mouldboard extension R
		BK013	3476001	Mouldboard extension L
		BK005	3441034	Mouldboard R
		BK005	3441035	Mouldboard L
		BK019	3441040	Mouldboard R
		BK019	3441041	Mouldboard L
			475MOLR	Brace fitting R
			475MOLL	Brace fitting L
			570MOL	Support for mouldboard
		BK007	3451000	Shin R
		BK007	3451001	Shin L
		BK007	3451002	Shin R (10mm)
		BK007	3451003	Shin L (10mm)
		BK010	3451010	Shin R (8mm)
		BK010	3451011	Shin L (8mm)
		BK140	4671002	Frog R
		BK140	4671003	Frog L
		BK140	4671010	Frog R
		BK140	4671011	Frog L
<b>Shares and points</b>				
		BK032	3365540	EUROPOINT rev. R
		Bk032	3365541	EUROPOINT rev. L
		BK036	3364050	EUROPOINT R
		BK036	3364051	EUROPOINT L
		BK036	3364150	EUROCARBIDE M5 point R
		BK036	3364151	EUROCARBIDE M5 point L
		BK036	3352010	EUROSHARE 14" R
		BK036	3352011	EUROSHARE 14" L
		BK036	3352020	EUROSHARE 16" R
		BK036	3352021	EUROSHARE 16" L
		BK036	3352030	EUROSHARE 18" R
		BK036	3352031	EUROSHARE 18" L
		BK036	3352130	EUROSHARE 18" R (11mm)
		BK036	3352131	EUROSHARE 18" L (11mm)
		BK036	MOL4150	M7-Adapter R
		BK036	MOL4151	M7-Adapter L
			MOL83	M7 point
			4879058	Wedge for M7 point
			4879056	Wedge for M7 point
		BK038	MOL2030C	EUROCARBIDE share 18" R
		BK038	MOL2031C	EUROCARBIDE share 18" L
		BK036	3352230	EUROCARBIDESHARE M5 18" R
		BK036	3352231	EUROCARBIDESHARE M5 18" L
<b>Landsides and share knives</b>				
		Bk008	3401900AK10	Landside, front R
		BK008	3401901AK10	Landside, front L
		BK036	3411500	Landside, short R&L
		BK036	3411504	Landside, long R&L
		Bk037	3411508	Landside, tall R&L
		BK037	3411460	Landside, tall R&L
		BK003	3492890	Share knife R
		BK003	3492891	Share knife L
<b>Parts to mount on landsides</b>				
		BK094	63600A	Wearing plate, rev. R&L
		BK094	63601A	Wearing plate, rev. R&L
		BK052	1349408	Sword coulter R
		BK052	1349409	Sword coulter L
		BK096	800MOL	Subsoiler blade R
		BK096	801MOL	Subsoiler blade L

Parts to fit:

# LEMKEN BS 40 ploughbody

**Bolt box no. Article-no. Designation**

**Mouldboards, shins and accessories**

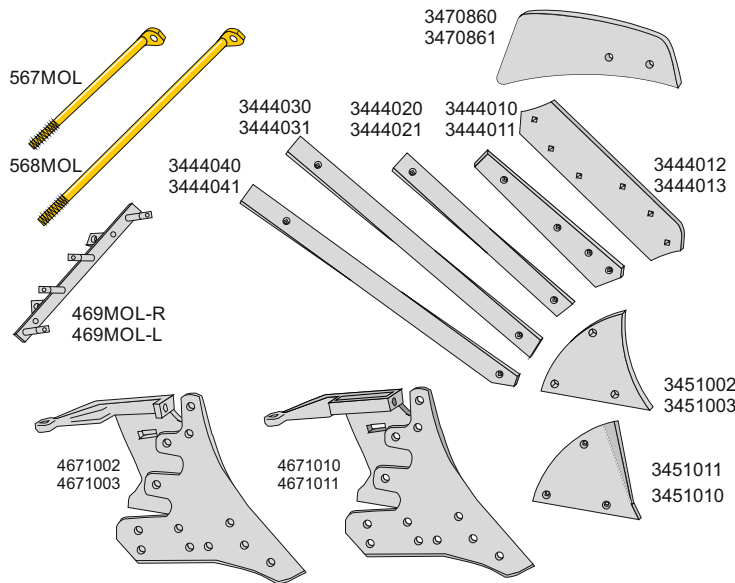

BK009	3470860	Turbo-trashboard R
BK009	3470861	Turbo-trashboard L
BK141	469MOL-R	Stay with support R
BK141	469MOL-L	Stay with support L
	567MOL	Support for stay, short
	568MOL	Support for stay, long
BK007	3451002	Shin R (10mm)
BK007	3451003	Shin L (10mm)
BK010	3451010	Shin R (8mm)
BK010	3451011	Shin L (8mm)
BK172	3444010	Mouldboard stripe R
BK172	3444011	Mouldboard stripe L
BK172	3444020	Mouldboard stripe R
BK172	3444021	Mouldboard stripe L
BK172	3444030	Mouldboard stripe R
BK172	3444031	Mouldboard stripe L
BK172	3444040	Mouldboard stripe R
BK172	3444041	Mouldboard stripe L
BK006	3444012	Rev. top stripe R
BK006	3444013	Rev. top stripe L
BK140	4671002	Frog R
BK140	4671003	Frog L
BK140	4671010	Frog R
BK140	4671011	Frog L

**Shares and points**

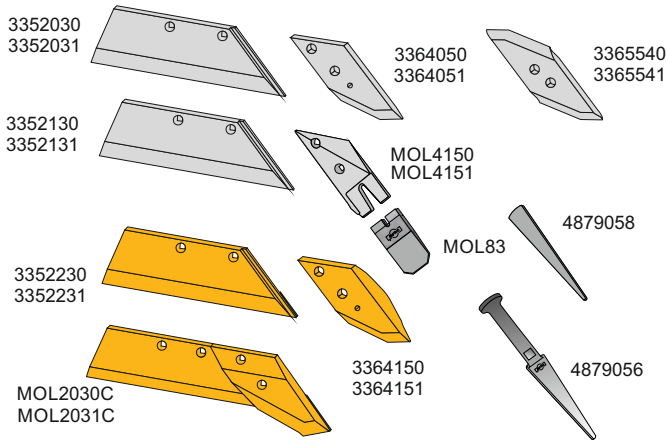

BK032	3365540	EUROPOINT rev. R
BK032	3365541	EUROPOINT rev. L
BK036	3364050	EUROPOINT R
BK036	3364051	EUROPOINT L
BK036	3364150	EUROCARBIDE M5 point R
BK036	3364151	EUROCARBIDE M5 point L
BK036	3352030	EUROSHARE 18" R
BK036	3352031	EUROSHARE 18" L
BK036	3352130	EUROSHARE 18" R (11mm)
BK036	3352131	EUROSHARE 18" L (11mm)
BK038	MOL2030C	EUROCARBIDE share 18" R
BK038	MOL2031C	EUROCARBIDE share 18" L
BK036	3352230	EUROCARBIDeshare M5 18" R
BK036	3352231	EUROCARBIDeshare M5 18" L
BK036	MOL4150	M7-Adapter R
BK036	MOL4151	M7-Adapter L
	MOL83	M7 point
	4879058	Wedge for M7 point
	4879056	Wedge for M7point

**Landsides and share knives**

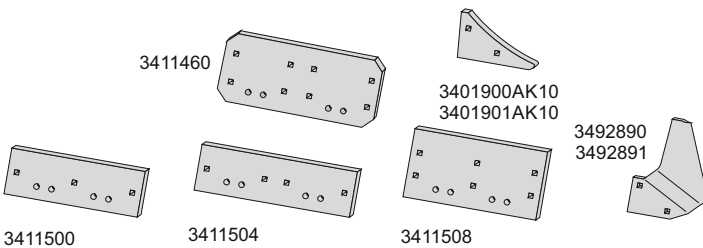

BK008	3401900AK10	Landside, front R
BK008	3401901AK10	Landside, front L
BK036	3411500	Landside, short R&L
BK036	3411504	Landside, long R&L
BK037	3411508	Landside, tall R&L
BK037	3411460	Landside, tall R&L
BK003	3492890	Share knife R
BK003	3492891	Share knife L

**Parts to mount on landsides**

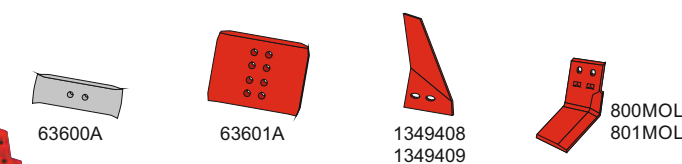

BK094	63600A	Wearing plate, rev. R&L
BK094	63601A	Wearing plate, rev. R&L
BK052	1349408	Sword coulter R
BK052	1349409	Sword coulter L
BK096	800MOL	Subsoiler blade R
BK096	801MOL	Subsoiler blade L

Parts to fit:

# LEMKEN BS 42 ploughbody

	<b>Bolt box no.</b>	<b>Article-no.</b>	<b>Designation</b>
<b>Mouldboards, shins and accessories</b>			
		3470860	BK009 3470860 Turbo-trashboard R
		3470861	BK009 3470861 Turbo-trashboard L
		4695600	BK141 469MOL-R Stay with support R
		4695601	BK141 469MOL-L Stay with support L
		3444010	4695600 Stay R
		3444011	4695601 Stay L
		3444012	567MOL Support for stay, short
		3444013	568MOL Support for stay, long
		3451002	BK007 3451002 Shin R (10mm)
		3451003	BK007 3451003 Shin L (10mm)
		3451010	BK010 3451010 Shin R (8mm)
		3451011	BK010 3451011 Shin L (8mm)
		3444010	BK172 3444010 Mouldboard stripe R
		3444011	BK172 3444011 Mouldboard stripe L
		3444020	BK172 3444020 Mouldboard stripe R
		3444021	BK172 3444021 Mouldboard stripe L
		3444030	BK172 3444030 Mouldboard stripe R
		3444031	BK172 3444031 Mouldboard stripe L
		3444042	BK173 3444042 Mouldboard stripe R
		3444043	BK173 3444043 Mouldboard stripe L
		3444012	BK006 3444012 Rev. top stripe R
		3444013	BK006 3444013 Rev. top stripe L
		4671002	BK140 4671002 Frog R
		4671003	BK140 4671003 Frog L
		4671010	BK140 4671010 Frog R
		4671011	BK140 4671011 Frog L
<b>Shares and points</b>			
		3365540	BK032 3365540 EUROPOINT rev. R
		3365541	BK032 3365541 EUROPOINT rev. L
		3364050	BK036 3364050 EUROPOINT R
		3364051	BK036 3364051 EUROPOINT L
		3364150	BK036 3364150 EUROCARBIDE M5 point R
		3364151	BK036 3364151 EUROCARBIDE M5 point L
		4879058	BK037 3352034 EUROSHARE 20" R
		4879056	BK037 3352035 EUROSHARE 20" L
			BK037 3352134 EUROSHARE 20" R (11mm)
			BK037 3352135 EUROSHARE 20" L (11mm)
			BK036 MOL4150 M7-Adapter R
			BK036 MOL4151 M7-Adapter L
			MOL83 M7 point
			4879058 Wedge for M7 point
			4879056 Wedge for M7 point
			BK039 MOL2034C EUROCARBIDE share 20" R
			BK039 MOL2035C EUROCARBIDE share 20" L
			BK037 3352234 EUROCARBIDEshare M5 20" R
			BK037 3352235 EUROCARBIDEshare M5 20" L
<b>Landsides and share knives</b>			
		3492890	BK008 3401900AK10 Landside, front R
		3492891	BK008 3401901AK10 Landside, front L
			BK036 3411500 Landside, short R&L
			BK036 3411504 Landside, long R&L
			BK037 3411508 Landside, tall R&L
			BK037 3411460 Landside, tall R&L
			BK003 3492890 Share knife R
			BK003 3492891 Share knife L
<b>Parts to mount on landsides</b>			
		63600A	BK094 63600A Wearing plate, rev. R&L
		63601A	BK094 63601A Wearing plate, rev. R&L
		1349408	BK052 1349408 Sword coulter R
		1349409	BK052 1349409 Sword coulter L
		800MOL	BK096 800MOL Subsoiler blade R
		801MOL	BK096 801MOL Subsoiler blade L

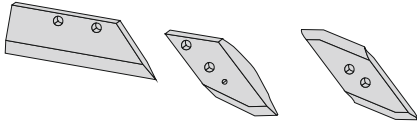
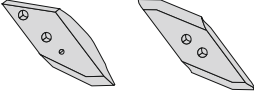
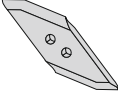
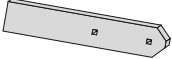

Parts to fit:

## LEMKEN BU ploughbody

		<u>Bolt box no.</u>	<u>Articel-no.</u>	<u>Designation</u>	
<b>Shares and points</b>					
 3351956 3351957	 3363986 3363987	 3365540 3365541	BK036	3351956	EUROSHARE 14" R
			BK036	3351957	EUROSHARE 14" L
			BK036	3363986	EUROPOINT rev. R
			BK036	3363987	EUROPOINT rev. L
			BK032	3365540	EUROPOINT R
			BK032	3365541	EUROPOINT L
<b>Landsides</b>					
 3401570			BK044	3401570	Landside, semilong R&L

Parts to fit:

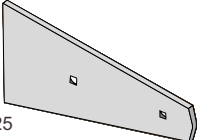
## LEMKEN CS Duramaxx ploughbody

<b>Landsides</b>					
 3411525				3411525	Landside R&L
	 3401903			3401903	Landside, front R&L

Parts to fit:

## LEMKEN ploughs

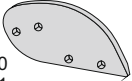
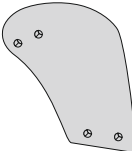
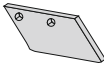
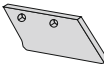
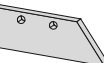
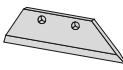
<b>Skim shares and skim mouldboards</b>					
 3470650 3470651	 3470600 3470601		BK001	3470650	Skim mouldboard R
				BK001	3470651
 3363720 3363721			BK003	3363720	Skim share R
			BK003	3363721	Skim share L
 3363712 3363713			BK003	3363710	Skim share R
			BK003	3363711	Skim share L
 3363710 3363711			BK003	3363712	Skim share R
			BK003	3363713	Skim share L
	 3363724		BK001	3470600	Skim mouldboard R
			BK001	3470601	Skim mouldboard L
			BK003	3363724	Skim share R&L

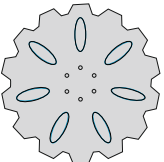
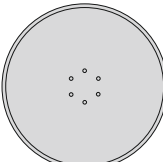
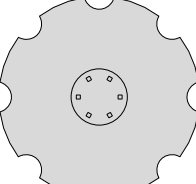
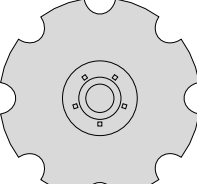
<b>Disc coulters</b>					
 3490042	 3490029			3490042	Disc coulters, notched Ø500mm
				3490029	Disc coulters, plain Ø500mm
 3490466	 3490467			3490466	Disc coulters, concave, notched Ø625mm
				3490467	Disc coulters, concave, notched Ø625mm

Parts to fit:

## LEMKEN C and C40 ploughbodies

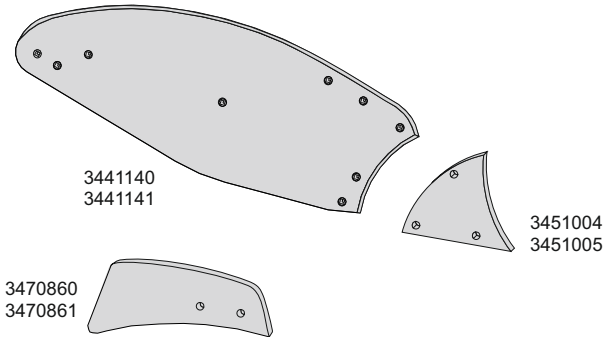
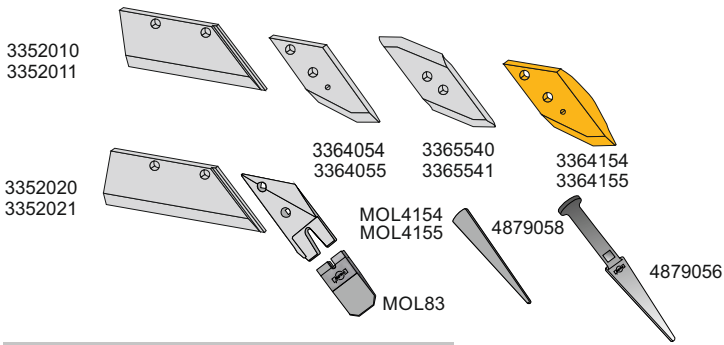
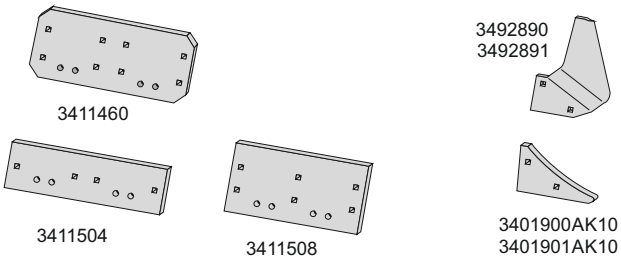
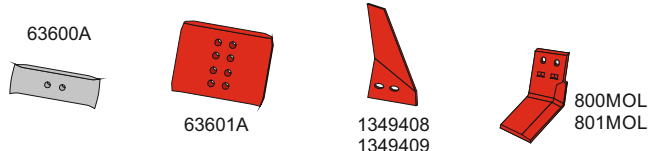
	<u>Bolt box no.</u>	<u>Article-no.</u>	<u>Designation</u>	
<b>Mouldboards, shins and accessories</b>				
 <p>3441140 3441141</p> <p>3470860 3470861</p> <p>3451004 3451005</p>	BK005	3441140	Mouldboard R	
	BK005	3441141	Mouldboard L	
	BK007	3451004	Shin R	
	BK007	3451005	Shin L	
	BK009	3470860	Turbo-trashboard R	
	BK009	3470861	Turbo-trashboard L	
	<b>Shares and points</b>			
	 <p>3352010 3352011</p> <p>3352020 3352021</p> <p>3364054 3364055</p> <p>3365540 3365541</p> <p>3364154 3364155</p> <p>MOL4154 MOL4155</p> <p>MOL83</p> <p>4879058</p> <p>4879056</p>	BK032	3365540	EUROPOINT rev. R
		BK032	3365541	EUROPOINT rev. L
BK036		3364054	EUROPOINT R	
BK036		3364055	EUROPOINT L	
BK036		3364154	EUROCARBIDE M5 point R	
BK036		3364155	EUROCARBIDE M5 point L	
BK036		3352010	EUROSHARE 14" R	
BK036		3352011	EUROSHARE 14" L	
BK036		3352020	EUROSHARE 16" R	
BK036		3352021	EUROSHARE 16" L	
BK036		MOL4154	M7-Adapter R	
BK036		MOL4155	M7-Adapter L	
BK036		MOL83	M7 point	
BK036		4879058	Wedge for M7 point	
BK036	4879056	Wedge for M7point		
<b>Landsides and share knives</b>				
 <p>3411460</p> <p>3411504</p> <p>3411508</p> <p>3492890 3492891</p> <p>3401900AK10 3401901AK10</p>	BK008	3401900AK10	Landside, front R	
	BK008	3401901AK10	Landside, front L	
	BK037	3411508	Landside, tall R&L	
	BK036	3411504	Landside, long R&L	
	BK037	3411460	Landside, tall R&L	
	BK003	3492890	Share knife R	
	BK003	3492891	Share knife L	
	<b>Parts to mount on landsides</b>			
	 <p>63600A</p> <p>63601A</p> <p>1349408 1349409</p> <p>800MOL 801MOL</p>	BK094	63600A	Wearing plate, rev. R&L
BK094		63601A	Wearing plate, rev. R&L	
BK052		1349408	Sword coulter R	
BK052		1349409	Sword coulter L	
BK096		800MOL	Subsoiler blade R	
BK096		801MOL	Subsoiler blade L	

### Did you know...

that Mølbros M5 EUROCARBID point is thicker than the original Lemken point.

Parts to fit:











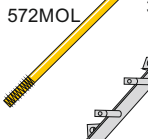

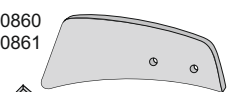
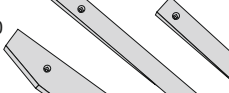

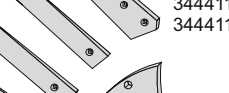
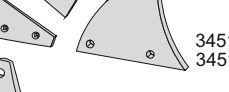
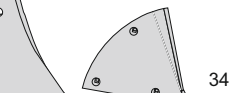
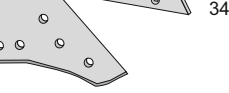
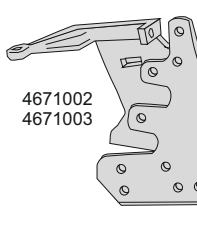
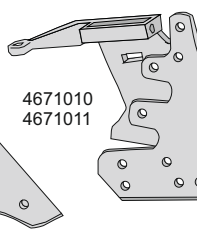
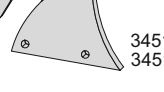
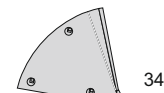
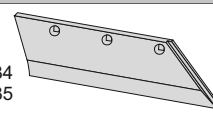
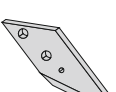
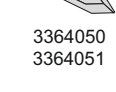
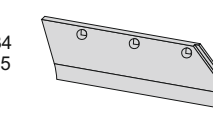
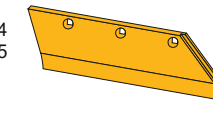
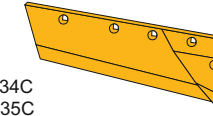
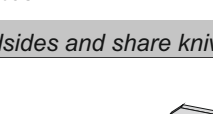
# LEMKEN US 35 ploughbody

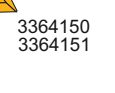
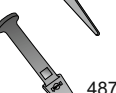
		<u>Bolt box no.</u>	<u>Article-no.</u>	<u>Designation</u>
<b>Mouldboards, shins and accessories</b>				
571MOL		3444130	3444120	3470860
		3444131	3444121	3470861
572MOL		3444134		
		3444135		
4691MOLR		3444110		
		3444111		
4691MOLL		3451002		
		3451003		
4671002		4671010		
		4671011		
4671003		4671010		
		4671011		
<b>Shares and points</b>				
3352030		BK032	3365540	EUROPOINT rev. R
		BK032	3365541	EUROPOINT rev. L
3352031		BK036	3364050	EUROPOINT R
		BK036	3364051	EUROPOINT L
3352130		BK036	3364150	EUROCARBIDE M5 point R
		BK036	3364151	EUROCARBIDE M5 point L
3352131		BK036	3352030	EUROSHARE 18" R
		BK036	3352031	EUROSHARE 18" L
3352230		BK036	3352130	EUROSHARE 18" R (11mm)
		BK036	3352131	EUROSHARE 18" L (11mm)
3352231		BK038	MOL2030C	EUROCARBIDE share 18" R
		BK038	MOL2031C	EUROCARBIDE share 18" L
MOL2030C		BK036	3352230	EUROCARBIDEshare M5 18" R
		BK036	3352231	EUROCARBIDEshare M5 18" L
MOL2031C		BK036	MOL4150	M7-Adapter R
		BK036	MOL4151	M7-Adapter L
			MOL83	M7 point
			4879058	Wedge for M7 point
			4879056	Wedge for M7point
<b>Landsides and share knives</b>				
3411460		BK008	3401900AK10	Landside, front R
		BK008	3401901AK10	Landside, front L
3411500		BK036	3411500	Landside, short R&L
		BK036	3411504	Landside, long R&L
3411504		BK037	3411508	Landside, tall R&L
		BK037	3411460	Landside, tall R&L
3411508		BK003	3492890	Share knife R
		BK003	3492891	Share knife L
3401900AK10				
3401901AK10				
<b>Parts to mount on landsides</b>				
63600A		BK094	63600A	Wearing plate, rev. R&L
		BK094	63601A	Wearing plate, rev. R&L
63601A		BK052	1349408	Sword coulter R
		BK052	1349409	Sword coulter L
1349408		BK096	800MOL	Subsoiler blade R
		BK096	801MOL	Subsoiler blade L
1349409				

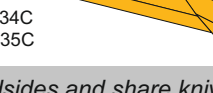
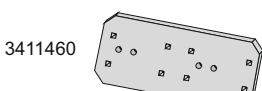
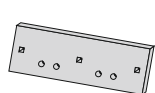
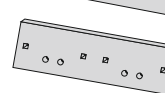
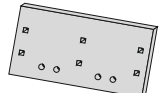
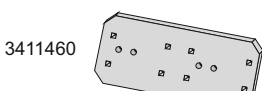

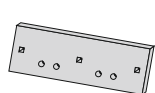
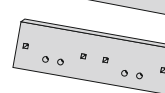
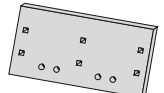
Parts to fit:

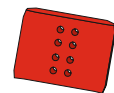
# LEMKEN US 40 ploughbody

	<u>Bolt box no.</u>	<u>Article-no.</u>	<u>Designation</u>
<b>Mouldboards, shins and accessories</b>			
		571MOL	
		572MOL	
		3444130 3444131 3444120 3444121	
	BK009	3470860	Turbo-trashboard R
	BK009	3470861	Turbo-trashboard L
		4691MOLR 4691MOLL	Stay with support R Stay with support L
		3444140 3444141	Support for stay, short Support for stay, long
	BK007	3451002	Shin L (10mm)
	BK007	3451003	Shin L (10mm)
	BK010	3451010	Shin R (8mm)
	BK010	3451011	Shin L (8mm)
	BK006	3444110	Mouldboard stripe R
	BK006	3444111	Mouldboard stripe L
	BK172	3444120	Mouldboard stripe R
	BK172	3444121	Mouldboard stripe L
	BK172	3444130	Mouldboard stripe R
	BK172	3444131	Mouldboard stripe L
	BK173	3444140	Mouldboard stripe R
	BK173	3444141	Mouldboard stripe L
	BK140	4671002	Frog R
	BK140	4671003	Frog L
	BK140	4671010	Frog R
	BK140	4671011	Frog L
	BK140	3451002	Frog R
	BK140	3451003	Frog L
	BK140	3451010	Frog R
	BK140	3451011	Frog L
<b>Shares and points</b>			
	BK032	3365540	EUROPOINT rev. R
	BK032	3365541	EUROPOINT rev. L
	BK036	3364050	EUROPOINT R
	BK036	3364051	EUROPOINT L
	BK036	3364150	EUROCARBIDE M5 point R
	BK036	3364151	EUROCARBIDE M5 point L
	BK037	3352034	EUROSHARE 20" R
	BK037	3352035	EUROSHARE 20" L
	BK037	3352134	EUROSHARE 20" R (11mm)
	BK037	3352135	EUROSHARE 20" L (11mm)
	BK039	MOL2034C	EUROCARBIDE share 20" R
	BK039	MOL2035C	EUROCARBIDE share 20" L
	BK037	3352234	EUROCARBIDEshare M5 20" R
	BK037	3352235	EUROCARBIDEshare M5 20" L
	BK036	MOL4150	M7-Adapter R
	BK036	MOL4151	M7-Adapter L
		MOL83	M7 point
		4879058	Wedge for M7 point
		3364150 3364151	Wedge for M7point
		4879056	Wedge for M7point
		4879058	Wedge for M7point
		MOL2034C MOL2035C	
<b>Landsides and share knives</b>			
	BK008	3401900AK10	Landside, front R
	BK008	3401901AK10	Landside, front L
	BK036	3411500	Landside, short R&L
	BK036	3411504	Landside, long R&L
	BK037	3411508	Landside, tall R&L
	BK037	3411460	Landside, tall R&L
	BK003	3492890	Share knife R
	BK003	3492891	Share knife L
		3401900AK10 3401901AK10	
		3411500	
		3411504	
		3411508	
<b>Parts to mount on landsides</b>			
	BK094	63600A	Wearing plate, rev. R&L
	BK094	63601A	Wearing plate, rev. R&L
	BK052	1349408	Sword coulter R
	BK052	1349409	Sword coulter L
	BK096	800MOL	Subsoiler blade R
	BK096	801MOL	Subsoiler blade L

Parts to fit:

## LEMKEN WG ploughbody

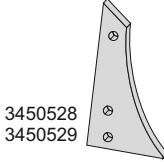
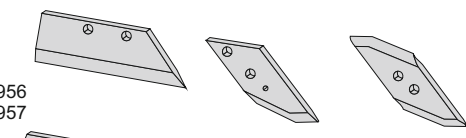
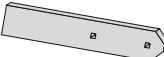
	<u>Bolt box no.</u>	<u>Article-no.</u>	<u>Designation</u>
<b>Shins</b>			
 3450528 3450529	BK010	3450528	Shin R
	BK010	3450529	Shin L
<b>Shares and knives</b>			
 3351956 3351957	BK032	3365540	EUROPOINT rev. R
	BK032	3365541	EUROPOINT rev. L
 3351958 3351959	BK036	3363986	EUROPOINT R
	BK036	3363987	EUROPOINT L
	BK036	3351956	EUROSHARE 14" R
	BK036	3351957	EUROSHARE 14" L
	BK036	3351958	EUROSHARE 16" R
	BK036	3351959	EUROSHARE 16" L
<b>Landside</b>			
 3401570	BK044	3401570	Landside, semi long R&L

Parts to fit:

## LEMKEN OPAL ploughbody

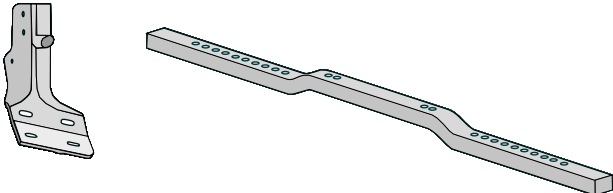
<b>Beams and accesories</b>			
		4570840	Frog 50x30x10 R
		4570841	Frog 50x30x10 L
		4644991	Beam L&R

Parts to fit:

## LEMKEN WS ploughbody

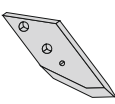
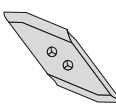
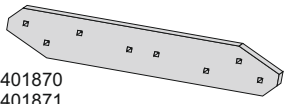
<b>Points</b>			
 3363980 3363981	BK032	3365540	EUROPOINT rev. R
	BK032	3365541	EUROPOINT rev. L
 3365540 3365541	BK036	3363980	EUROPOINT R
	BK036	3363981	EUROPOINT L
<b>Landside</b>			
 3401870 3401871	BK038	3401870	Landside, semilong R
	BK038	3401871	Landside, semilong L

Parts to fit:

## MASSEY-FERGUSON FC ploughbody

Numbers in ( ) are original Massey-Ferguson numbers.  
Please use art. no. **without** ( ), when ordering.

**Bolt box no. Article-no. Designation**

### Mouldboards, shins and accessories

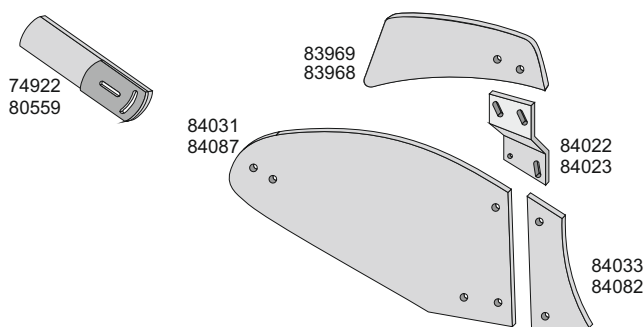

BK167	83969 (3940301)	Turbo-trashboard R
BK167	83968 (3940300)	Turbo-trashboard L
	84022 (3940303)	Fittings for trashboard R
	84023 (3940304)	Fittings for trashboard L
BK062	84031 (3940305)	Mouldboard R
BK062	84087 (3940317)	Mouldboard L
BK082	74922 (3940234)	Mouldboard extension R
BK082	80559 (3940262)	Mouldboard extension L
BK065	84033 (3940306)	Shin R
BK065	84082 (3940315)	Shin L

### Shares and points

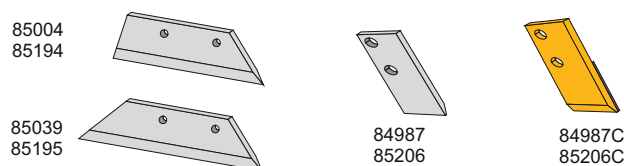

BK052	85004 (3940330)	EUROSHARE 16" R
BK052	85194 (3940334)	EUROSHARE 16" L
BK052	85039 (3940332)	EUROSHARE 18" R
BK052	85195 (3940335)	EUROSHARE 18" L
BK031	84987 (3940328)	EUROPOINT R
BK031	85206 (3940337)	EUROPOINT L
BK031	84987C	EUROCARBIDE M5 point R
BK031	85206C	EUROCARBIDE M5 point L

### Landsides and share knives

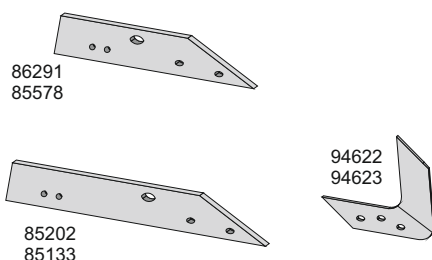

BK084	94622 (3940746)	Share knife R
BK084	94623 (3940745)	Share knife L
BK073	86291 (3940391)	Landside, short R
BK073	85578 (3940359)	Landside, short L
BK073	85202 (3940700)	Landside, long R
BK073	85133 (3940810)	Landside, long L

### Parts to mount on landsides

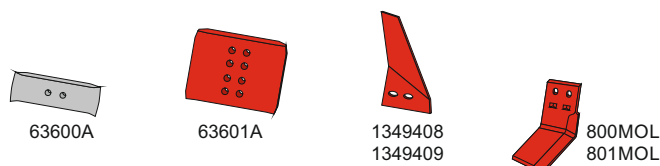

BK094	63600A	Wearing plate, rev. R&L
BK094	63601A	Wearing plate, rev. R&L
BK052	1349408	Sword coulter R
BK052	1349409	Sword coulter L
BK096	800MOL	Subsoiler blade R
BK096	801MOL	Subsoiler blade L

## Did you know...

that all Mølbros landsides are equipped with mounting holes for our full range of landside accessories.



Parts to fit:

# MASSEY-FERGUSON AH ploughbody

Numbers in ( ) are original Massey-Ferguson numbers.  
Please use art. no. **without** ( ), when ordering.

**Bolt box no. Article-no. Designation**

## Mouldboards, shins and accessories

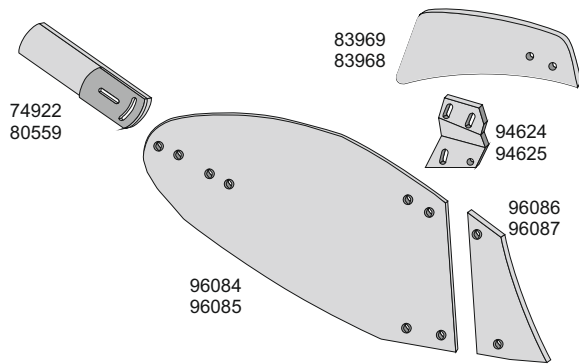

BK082	74922 (3940234)	Mouldboard extension R
BK082	80559 (3940262)	Mouldboard extension L
BK167	83969 (3941789)	Turbo-trashboard R
BK167	83968 (3941790)	Turbo-trashboard L
BK082	94624 (3942733)	Fittings for trashboard R
BK082	94625 (3942732)	Fittings for trashboard L
BK067	96084 (3941973)	Mouldboard R
BK067	96085 (3941972)	Mouldboard L
BK052	96086 (3941975)	Shin R
BK052	96087 (3941974)	Shin L

## Shares and points

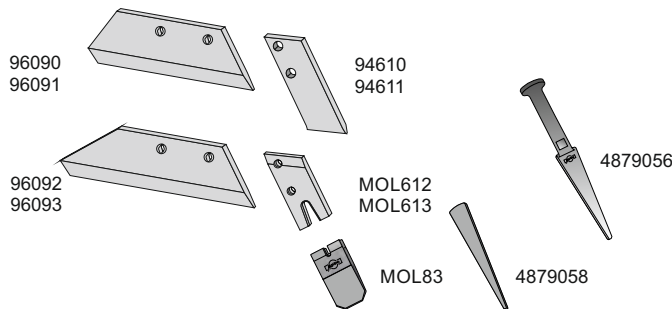

BK052	96090 (39411969)	EUROSHARE 16" R
BK052	96091 (39411968)	EUROSHARE 16" L
BK052	96092 (39411971)	EUROSHARE 18" R
BK052	96093 (39411970)	EUROSHARE 18" L
BK031	94610 (3940742)	EUROPOINT R
BK031	94611 (3940741)	EUROPOINT L
BK031	MOL612	M7-Adapter R
BK031	MOL613	M7-Adapter L
	MOL83	M7 point rev. R/L
	4879058	Wedge for M7 point
	4879056	Wedge for M7point

## Landsides and share knives

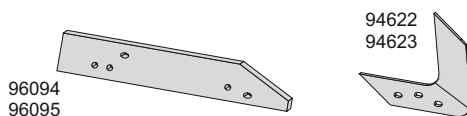

BK069	96094 (39411967)	Landside R
BK069	96095 (39411966)	Landside L
BK084	94622 (3940746)	Share knife R
BK084	94623 (3940745)	Share knife L

## Parts to mount on landsides

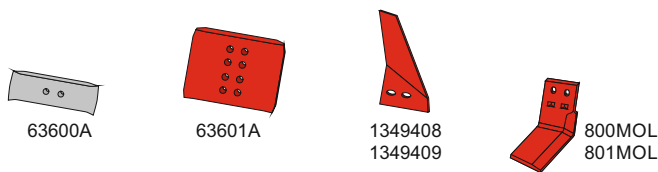

BK094	63600A	Wearing plate, rev. R&L
BK094	63601A	Wearing plate, rev. R&L
BK052	1349408	Sword coulter R
BK052	1349409	Sword coulter L
BK096	800MOL	Subsoiler blade R
BK096	801MOL	Subsoiler blade L

Parts to fit:

# MASSEY-FERGUSON AS ploughbody

Numbers in ( ) are original Massey-Ferguson numbers.  
Please use art. no. **without** ( ), when ordering.

**Bolt box no. Article-no. Designation**

## Mouldboards, shins and accessories

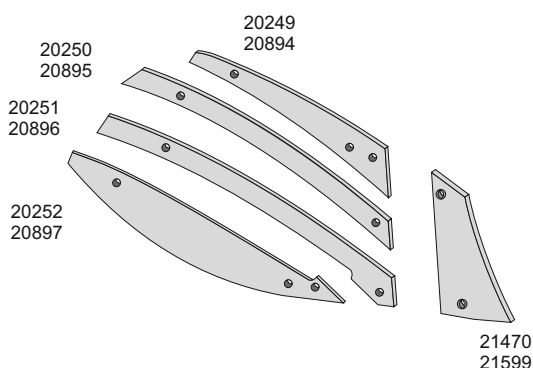

<i>BK058</i>	20249 (3942705)	Mouldboard stripe R
<i>BK058</i>	20894 (3942712)	Mouldboard stripe L
<i>BK052</i>	20250 (3942706)	Mouldboard stripe R
<i>BK052</i>	20895 (3942713)	Mouldboard stripe L
<i>BK052</i>	20251 (3942707)	Mouldboard stripe R
<i>BK052</i>	20896 (3942714)	Mouldboard stripe L
<i>BK058</i>	20252 (3942708)	Mouldboard stripe R
<i>BK058</i>	20897 (3942715)	Mouldboard stripe L
<i>BK052</i>	21470 (3942730)	Shin R
<i>BK052</i>	21599 (3942729)	Shin L

## Shares and points

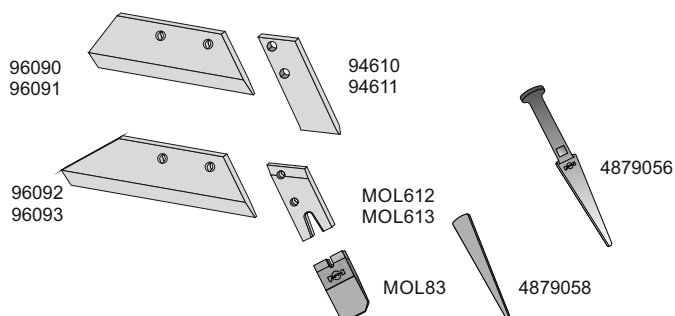

<i>BK052</i>	96090 (39411969)	EUROSHARE 16" R
<i>BK052</i>	96091 (39411968)	EUROSHARE 16" L
<i>BK052</i>	96092 (39411971)	EUROSHARE 18" R
<i>BK052</i>	96093 (39411970)	EUROSHARE 18" L
<i>BK031</i>	94610 (3940742)	EUROPOINT R
<i>BK031</i>	94611 (3940741)	EUROPOINT L
<i>BK031</i>	MOL612	M7-Adapter R
<i>BK031</i>	MOL61	M7-Adapter L
	MOL83	M7 point rev. R/L
	4879058	Wedge for M7 point
	4879056	Wedge for M7 point

## Landsides and share knives

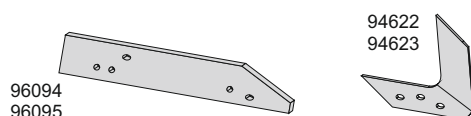

<i>BK069</i>	96094 (39411967)	Landside R
<i>BK069</i>	96095 (39411966)	Landside L
<i>BK084</i>	94622 (3940746)	Share knife R
<i>BK084</i>	94623 (3940745)	Share knife L

## Parts to mount on landsides

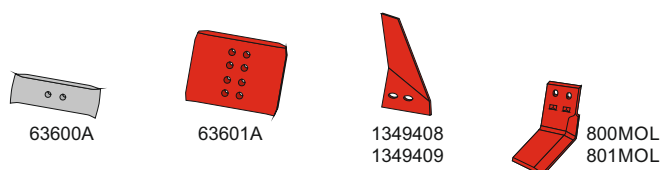

<i>BK094</i>	63600A	Wearing plate, rev. R&L
<i>BK094</i>	63601A	Wearing plate, rev. R&L
<i>BK052</i>	1349408	Sword coulter R
<i>BK052</i>	1349409	Sword coulter L
<i>BK096</i>	800MOL	Subsoiler blade R
<i>BK096</i>	801MOL	Subsoiler blade L



Parts to fit:

# MASSEY-FERGUSON AX ploughbody

Numbers in ( ) are original Massey-Ferguson numbers.  
Please use art. no. **without** ( ), when ordering.

**Bolt box no. Article-no. Designation**

## Mouldboards, shins and accessories

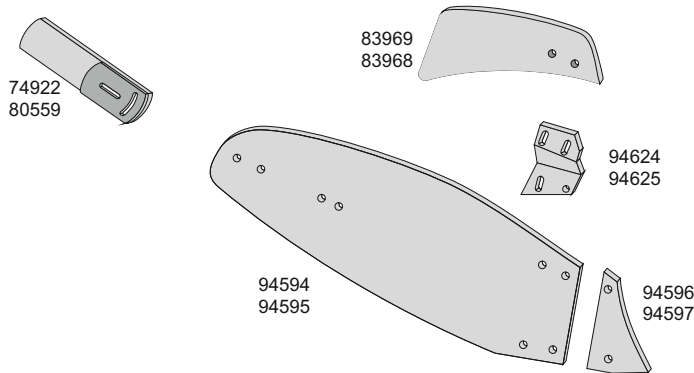

BK082	74922 (3940234)	Mouldboard extension R
BK082	80559 (3940262)	Mouldboard extension L
BK167	83969 (3941789)	Turbo-trashboard R
BK167	83968 (3941790)	Turbo-trashboard L
BK082	94624 (3942733)	Fittings for trashboard R
BK082	94625 (3942732)	Fittings for trashboard L
BK066	94594 (3940744)	Mouldboard R
BK066	94595 (3940743)	Mouldboard L
BK052	94596 (3940704)	Shin R
BK052	94597 (3940705)	Shin L

## Shares and points

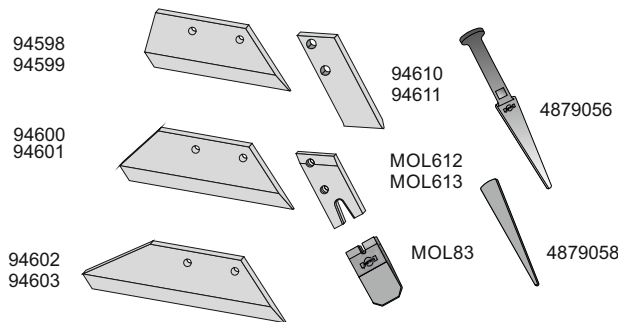

BK052	94598 (3940706)	EUROSHARE 14" R
BK052	94599 (3940707)	EUROSHARE 14" L
BK052	94600 (3940708)	EUROSHARE 16" R
BK052	94601 (3940709)	EUROSHARE 16" L
BK052	94602 (3940710)	EUROSHARE 18" R
BK052	94603 (3940711)	EUROSHARE 18" L
BK031	94610 (3940742)	EUROPOINT R
BK031	94611 (3940741)	EUROPOINT L
BK031	MOL612	M7-Adapter R
BK031	MOL613	M7-Adapter L
	MOL83	M7 point rev. R/L
	4879058	Wedge for M7 point
	4879056	Wedge for M7point

## Landsides and share knives

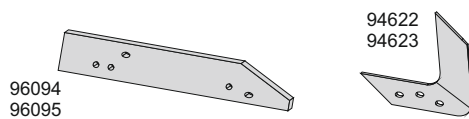

BK074	94606 (3940714)	Landside R
BK074	94607 (3940715)	Landside L
BK084	94622 (3940746)	Share knife R
BK084	94623 (3940745)	Share knife L

## Parts to mount on landsides

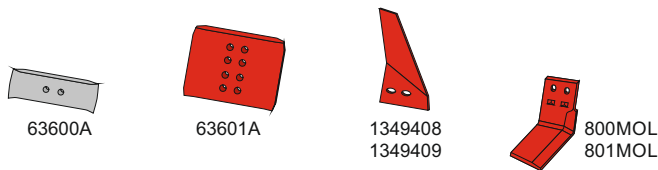

BK094	63600A	Wearing plate, rev. R&L
BK094	63601A	Wearing plate, rev. R&L
BK052	1349408	Sword coulter R
BK052	1349409	Sword coulter L
BK096	800MOL	Subsoiler blade R
BK096	801MOL	Subsoiler blade L

Parts to fit:

## MASSEY-FERGUSON FK ploughbody

Numbers in ( ) are original Massey-Ferguson numbers.  
Please use art. no. **without** ( ), when ordering.

**Bolt box no. Article-no. Designation**

### Mouldboard, shin and accessories

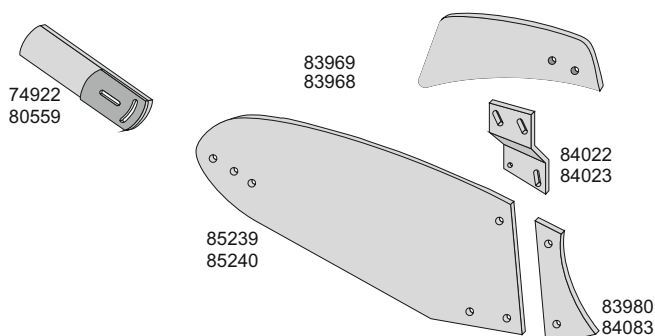

BK167	83969 (3940301)	Turbo-trashboard R
BK167	83968 (3940300)	Turbo-trashboard L
	84022 (3940303)	Fittings for trashboard R
	84023 (3940304)	Fittings for trashboard L
BK063	85239 (3940342)	Mouldboard R
BK063	85240 (3940343)	Mouldboard L
BK082	74922 (3940234)	Mouldboard extension R
BK082	80559 (3940262)	Mouldboard extension L
BK065	83980 (3940302)	Shin R
BK065	84083 (3940316)	Shin L

### Shares and points

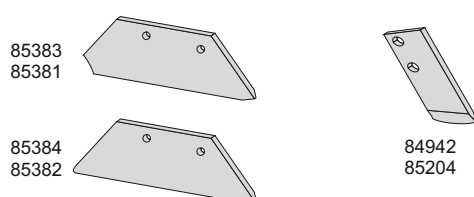

BK052	85383 (3940312)	EUROSHARE 14" R
BK052	85381 (3940314)	EUROSHARE 14" L
BK052	85384 (3940347)	EUROSHARE 16" R
BK052	85382 (3940345)	EUROSHARE 16" L
BK031	84942 (3940326)	EUROPOINT R
BK031	85204 (3940336)	EUROPOINT L

### Landsides and share knives

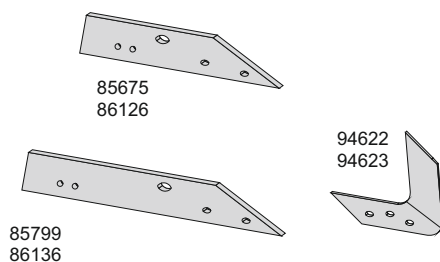

BK084	94622 (3940746)	Share knife R
BK084	94623 (3940745)	Share knife L
BK073	85675 (3940363)	Landside, short R
BK073	86126 (3940385)	Landside, short L
BK073	85799	Landside, long R (3940740)
BK073	86136	Landside, long L (3940701)

### Parts to mount on landsides

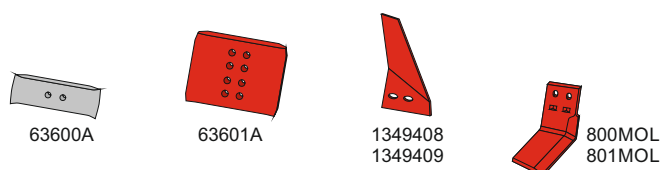

BK094	63600A	Wearing plate, rev. R&L
BK094	63601A	Wearing plate, rev. R&L
BK052	1349408	Sword coulter R
BK052	1349409	Sword coulter L
BK096	800MOL	Subsoiler blade R
BK096	801MOL	Subsoiler blade L

Parts to fit:

## MASSEY-FERGUSON ploughs

Numbers in ( ) are original Massey-Ferguson numbers.  
Please use art. no. **without** ( ), when ordering.

**Bolt box no. Article-no. Designation**

### Skim shares and skim mouldboards

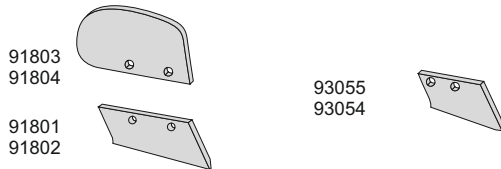

<i>BK052</i>	91803 (3940501)	Skim mouldboard R
<i>BK052</i>	91804 (3940502)	Skim mouldboard L
<i>BK052</i>	91801 (3940499)	Skim share R
<i>BK052</i>	91802 (3940500)	Skim share L
<i>BK052</i>	93055 (3940770)	Skim share R
<i>BK052</i>	93054 (3940771)	Skim share L

### Disc coulters and accessories

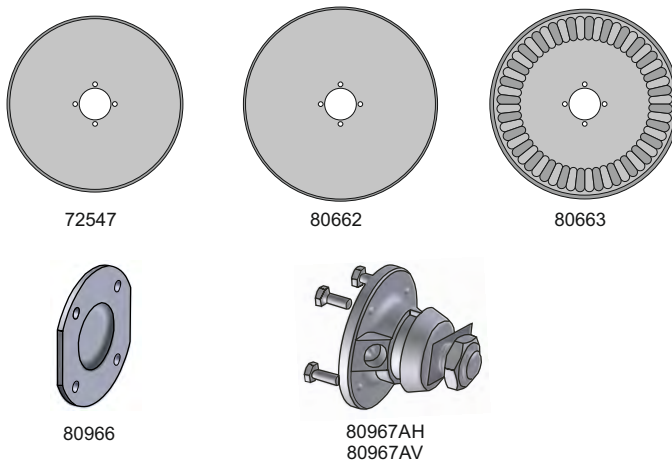

72547(3940221)	Disc coultter 18" R&L
80662 (3940268)	Disc coultter 20" R&L
80663 (3940269)	Disc coultter, rippled 20" R&L
80966 (3940277)	Cover for disc coultter R&L
80967AH	Hub for disc coultter M30 R
80967AV	Hub for disc coultter M30 L

Parts to fit:

## KRONE KG ploughs

### Shares and points

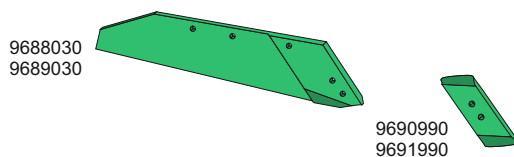

<i>BK099</i>	09688030	EUROSHARE f/rev. point R
<i>BK099</i>	09689030	EUROSHARE f/rev. point L
<i>BK101</i>	09690990	EUROPOINT rev. R
<i>BK101</i>	09691990	EUROPOINT rev. L

### Landsides

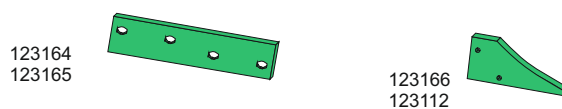



0123164	Landside, long R	
0123165	Landside, long L	
<i>BK098</i>	0123166	Landside, front R
<i>BK098</i>	0123112	Landside, front L

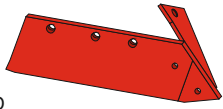
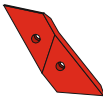
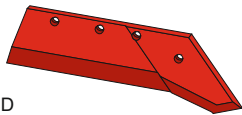
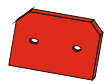

Parts to fit:

## NAUD ploughs

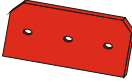
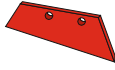
	<u>Bolt box no.</u>	<u>Article-no.</u>	<u>Designation</u>
<b>Skær og spidser</b>			
 N031189D N031189G		N031189D N031189G	EUROSHARE R EUROSHARE L
	 N031235D N031235G		N031235D N031235G
 03055504D 03055504G			03055504D 03055504G
<b>Landsides and share knives</b>			
 N031190	 N031194D N031194G	N031190	Landside R&L
		N031191	Landside R&L
 N031191	 N031193D N031193G	N031192	Landside R&L
		N031193D N031193G	Share knife R Share knife L
 N031192		N031194D N031194G	Share knife R Share knife L
<b>Skim share</b>			
 N031241D N031241G		N031241D	Skim share
		N031241G	Skim share

Parts to fit:

## NIEMEYER ploughs

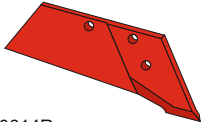
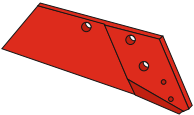
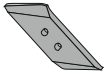
<b>Shares and points</b>				
 200614R 200615L	 200616R 200617L	 024104R 024105L	BK037 200614R BK037 200615L	EUROSHARE R EUROSHARE L
			BK037 200616R BK037 200617L	EUROSHARE f/rev. point R EUROSHARE f/rev. point L
			BK094 024104R BK094 024105L	EUROPOINT, rev. R EUROPOINT, rev. L

Parts to fit:

# PÖTTINGER ploughbodies 36W and 41W

Mouldboards, shins and accessories		Bolt box no.	Article-no.	Designation
73800		BK167	73/63-300	Turbo-trashboard R
73801		BK167	73/63-301	Turbo-trashboard L
53387			73/63-310	Fittings for trashboard R
63388			73/63-311	Fittings for trashboard L
73803		BK156	73803	Brace R&L
73290		BK113	73800	Brace fitting R
73291		BK113	73801	Brace fitting L
73286		BK082	53387	Mouldboard extension R
73287		BK082	63388	Mouldboard extension L
		BK059	73290	Mouldboard R
		BK059	73291	Mouldboard L
		BK056	73286	Mouldboard R
		BK056	73287	Mouldboard L
		BK058	73256	Shin R
		BK058	73257	Shin L
		BK052	73250	Shin R
		BK052	73251	Shin L
			73266	Bracket for shin R
			73267	Bracket for shin L
93070			93070	Frog R
93071			93071	Frog L
Shares, points and accessories				
073002		BK113	073002	EUROSHARE 14" R
073003		BK113	073003	EUROSHARE 14" L
073004		BK113	073004	EUROSHARE 16" R
073005		BK113	073005	EUROSHARE 16" L
073004-14			073004-14	EUROSHARE 16" R 14mm
073005-14			073005-14	EUROSHARE 16" L 14mm
073006		Bk114	073006	EUROSHARE 18" R
073007		BK114	073007	EUROSHARE 18" L
073008		BK114	073008	EUROSHARE 20" R
073009		BK114	073009	EUROSHARE 20" L
		BK170	83018	EUROSHARE M5 16" R
		BK170	83019	EUROSHARE M5 16" L
		BK170	83020	EUROSHARE M5 18" R
		BK170	83021	EUROSHARE M5 18" L
		BK170	83022	EUROSHARE M5 20" R
		BK170	83023	EUROSHARE M5 20" L
		BK144	83010C	EUROCARBIDE M5 point R
		BK144	83011C	EUROCARBIDE M5 point L
MOL83018C		BK144	MOL83-0	M7-adaptor R
MOL83019C		BK144	MOL83-1	M7-adaptor L
			MOL83	M7 point rev. R/L
			4879058	Wedge for M7 point
			4879056	Wedge for M7 point
83018		BK095	73091	Share knife R
83019		BK095	73092	Share knife L
		BK094	53090	EUROPOINT Rev. R
		BK094	63090	EUROPOINT Rev. L
83020		BK095	5309MOLC	EUROCARBIDE point R
83021		BK095	6309MOLC	EUROCARBIDE point L
83022			73414	Bracket for 18" and 20" shares R
83023			73415	Bracket for 18" and 20" shares L
		BK170	MOL83018C	EUROCARBIDE M5 share 16" R
		BK170	MOL83019C	EUROCARBIDE M5 share 16" L
		BK170	MOL83020C	EUROCARBIDE M5 share 18" R
		BK170	MOL83021C	EUROCARBIDE M5 share 18" L
Landsides and share knives				
			929100101	Landside, long R&L
		BK095	930700050	Skim point R
		BK095	930710050	Skim point L

Parts to fit:

# PÖTTINGER ploughbody 46W

**Mouldboards, shins and accessories** **Bolt box no. Article-no. Designation**

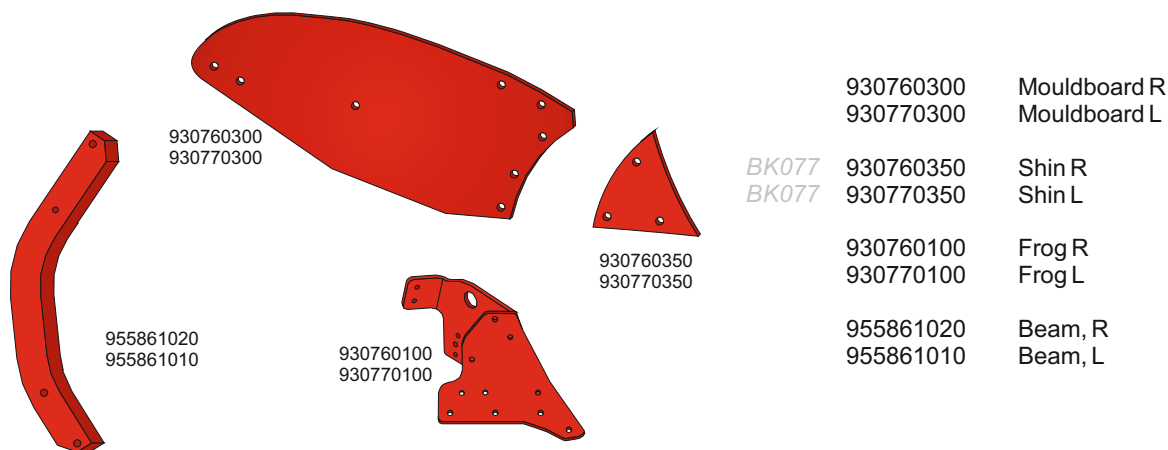

	930760300	Mouldboard R
	930770300	Mouldboard L
BK077	930760350	Shin R
BK077	930770350	Shin L
	930760100	Frog R
	930770100	Frog L
	955861020	Beam, R
	955861010	Beam, L

**Shares, points and accessories**

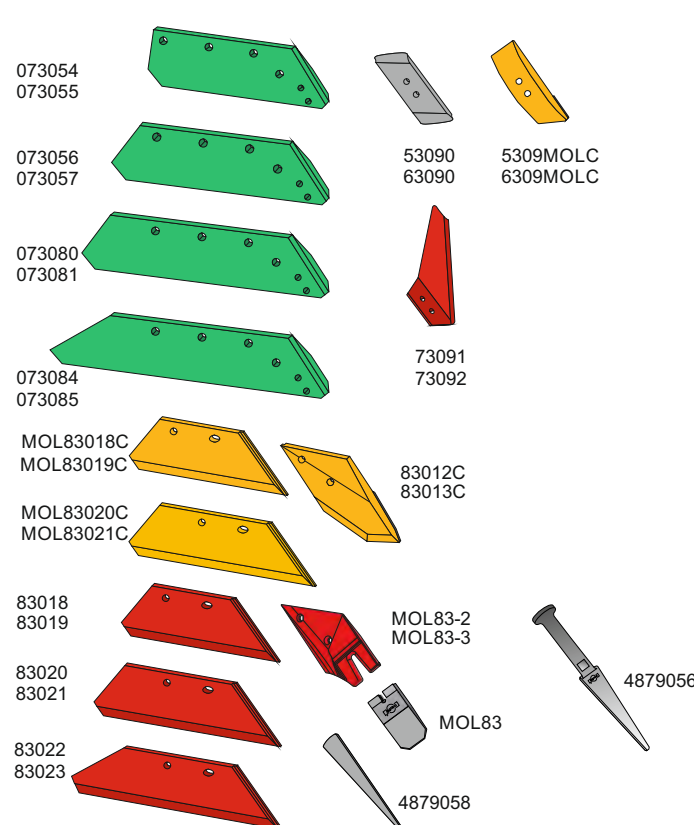

	073054	EUROSHARE 14" R
	073055	EUROSHARE 14" L
	073056	EUROSHARE 16" R
	073057	EUROSHARE 16" L
	073080	EUROSHARE 18" R
	073081	EUROSHARE 18" L
	073084	EUROSHARE 20" R
	073085	EUROSHARE 20" L
	73091	Share knife R
	73092	Share knife L
	53090	EUROPOINT Rev. R
	63090	EUROPOINT Rev. L
	5309MOLC	EUROCARBIDE point R
	6309MOLC	EUROCARBIDE point L
	83018	EUROSHARE M5 16" R
	83019	EUROSHARE M5 16" L
	83020	EUROSHARE M5 18" R
	83021	EUROSHARE M5 18" L
	83022	EUROSHARE M5 20" R
	83023	EUROSHARE M5 20" L
	83012C	EUROCARBIDE M5 point R
	83013C	EUROCARBIDE M5 point L
	MOL83-0	M7-adapter R
	MOL83-1	M7-adapter L
	MOL83	M7 point rev. R/L
	4879058	Wedge for M7 point
	4879056	Wedge for M7 point
	MOL83018C	EUROCARBIDE M5share16" R
	MOL83019C	EUROCARBIDE M5share16" L
	MOL83020C	EUROCARBIDE M5share18" R
	MOL83021C	EUROCARBIDE M5share18" L

**Landsides**

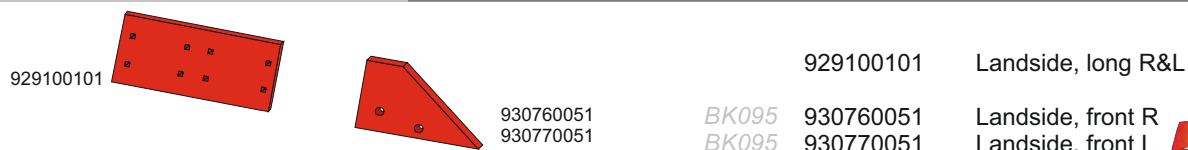





	929100101	Landside, long R&L
BK095	930760051	Landside, front R
BK095	930770051	Landside, front L

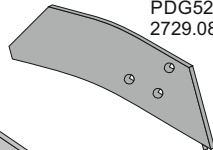
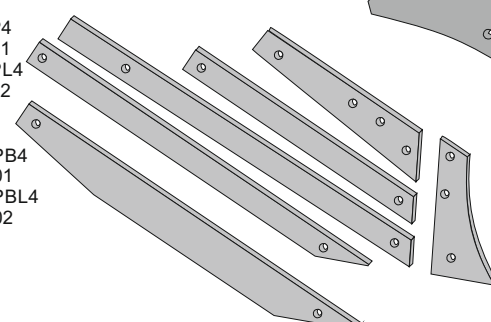
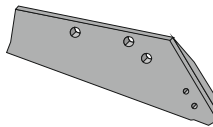
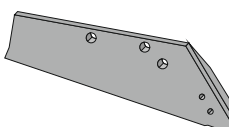
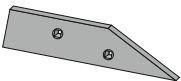

Parts to fit

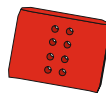
# RABEWERK ploughbodies BP-321, 322, 323 PS/PSL

				<u>Bolt box no.</u>	<u>Article-no.</u>	<u>Designation</u>
<b>Mouldboards , shins and accessories</b>						
SRP328P3 2731.11.01	SRP328P2 2731.10.01	SRP328P1 2731.09.01		PDG52 2729.08.01	BK077 PDG52	Trashboard R
SRP328PL3 2731.11.02	SRP328PL2 2731.10.02	SRP328PL1 2731.09.02		PDG52L 2729.08.02	BK077 PDG52L	Trashboard L
SRP328P4 2731.12.01				BK078 SRP328P1	BK078 SRP328PL1	Mouldboard stripe R
SRP328PL4 2731.12.02				BK069 SRP328P2	BK069 SRP328PL2	Mouldboard stripe R
SRP327PB4 2731.08.01				BK069 SRP328P3	BK069 SRP328PL3	Mouldboard stripe L
				SRP327PBL4 2731.08.02	BK069 SRP328P4	BK069 SRP328PL4
				BK069 SRP327PB4	BK069 SRP327PBL4	Mouldboard stripe L
				VRP342R 2704.01.01	BK058 VRP342R	Shin R (10 mm)
				VRP342RL 2704.01.02	BK058 VRP342RL	Shin L (10 mm)
<b>Shares and points</b>						
SSP293OSE 2701.33.01				BK094 MP293	BK094 MP293L	EUROPOINT, rev. R
SSP293OSEL 2701.33.02				BK094 MP293L	BK094 MP293L	EUROPOINT, rev. L
				BK037 SSP293OSE	BK037 SSP293OSEL	EUROSHARE R
				BK037 SSP294OSE	BK037 SSP294OSEL	EUROSHARE L
				BK037 SSP294OSE	BK037 SSP294OSEL	EUROSHARE R
				BK037 SSP294OSEL	BK037 SSP294OSEL	EUROSHARE L
SSP294OSE 2707.04.01				MP293 2701.12.01	MP293L 2701.12.02	
SSP294OSEL 2707.04.01				MP293L 2701.12.02	MP293L 2701.12.02	
<b>Landsides and share knives</b>						
				BK033 VP292O	BK040 WP292O	Landside, short R&L
VP292O 2701.15.00				BK040 WP292O	BK040 WP292O	Landside, long R&L
				WP292O 2701.14.00		
<b>Parts to mount on landsides</b>						
				BK094 63600A	BK094 63601A	Wearing plate, rev. R&L
63600A				63601A	1349408 1349409	BK052 1349408
				BK096 800MOL	BK096 801MOL	Sword coulter L
				BK096 800MOL	BK096 801MOL	Subsoiler blade R
				BK096 801MOL	BK096 801MOL	Subsoiler blade L



Parts to fit:

## RABEWERK ploughbodies BP-350 WS/WSL

				<u>Bolt box no.</u>	<u>Article-no.</u>	<u>Designation</u>
<b>Mouldboards, shins and accessories</b>						
SRP350W3 2755.03.01 SRP350WL3 2755.03.02	SRP350W2 2755.02.01 SRP350WL2 2755.02.02	SRP350W1 2755.01.01 SRP350WL1 2755.01.02	PDG52 2729.08.01 PDG52L 2729.08.02	BK077	PDG52	Trashboard R
				BK077	PDG52L	Trashboard L
SRP350W4 2755.04.01 SRP350WL4 2755.04.02				BK052	SRP350W1	Mouldboard stripe R
				BK052	SRP350WL1	Mouldboard stripe L
				BK052	SRP350W2	Mouldboard stripe R
				BK052	SRP350WL2	Mouldboard stripe L
				BK052	SRP350W3	Mouldboard stripe R
				BK052	SRP350WL3	Mouldboard stripe L
				BK052	SRP350W4	Mouldboard stripe R
				BK052	SRP350WL4	Mouldboard stripe L
SRP350W41 2755.07.01 SRP350WL41 2755.07.02				BK052	SRP350W41	Mouldboard stripe R
				BK052	SRP350WL41	Mouldboard stripe L
			VRP350W 2758.01.01 VRP350WL 2758.01.02	BK069	VRP350W	Shin R (10 mm)
				BK069	VRP350WL	Shin L (10 mm)
<b>Shares and Knives</b>						
SSP350WSE 2751.22.01 SSP350WSEL 2751.22.02				BK094	MP350	EUROPOINT, rev. R
				BK094	MP350L	EUROPOINT, rev. L
				BK095	MOL350C	EUROCARBIDE M3 point R
				BK095	MOL350LC	EUROCARBIDE M3 point L
	MP350 2751.09.01 MP350L 2751.09.02			BK038	SSP350WSE	EUROSHARE R
		MOL350C MOL350LC		BK038	SSP350WSEL	EUROSHARE L
SSP351WEP 2751.30.01 SSP351WEPL 2751.30.02				BK038	SSP351WEP	EUROCARBIDE share R
				BK038	SSP351WEPL	EUROCARBIDE share L
<b>Landsides and share knives</b>						
WP351W 2751.03.05				BK042	WP351W	Landside, rev. R&L
	VP351W 2751.03.06			BK042	VP351W	Landside, short, rev. R&L
		YP350W 2751.02.05		BK041	YP350W	Skim point, rev. R&L

**Did you know...**

that Mølbros process around 4000 tons boron steel from Scandinavia every year.



Parts to fit:

# RABEWERK ploughbodies BP-2930, 2940 L

**Bolt box no. Article-no. Designation**

## Mouldboards, shins and accessories

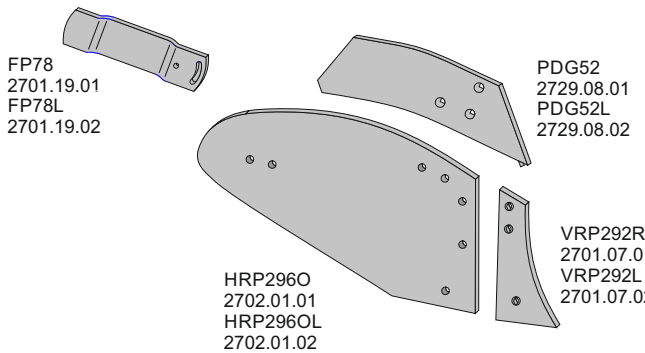
 <p>FP78 2701.19.01 FP78L 2701.19.02</p> <p>HRP2960 2702.01.01 HRP296OL 2702.01.02</p> <p>PDG52 2729.08.01 PDG52L 2729.08.02</p> <p>VRP292R 2701.07.01 VRP292L 2701.07.02</p>	<p>BK077 PDG52 Trashboard R BK077 PDG52L Trashboard L</p> <p>FP78 Mouldboard extension R FP78L Mouldboard extension L HRP2960 Mouldboard R HRP296OL Mouldboard L BK058 VRP292R Shin R BK058 VRP292L Shin L</p>
--	--

## Shares and points

 <p>SSP293OSE 2701.33.01 SSP293OSEL 2701.33.02</p> <p>SSP294OSE 2707.04.01 SSP294OSEL 2707.04.02</p> <p>MOL294C MOL294CL</p> <p>MP293 2701.12.01 MP293L 2701.12.02</p>	<p>BK094 MP293 EUROPOINT, rev. R BK094 MP293L EUROPOINT, rev. L</p> <p>BK037 SSP293OSE EUROSARE R BK037 SSP293OSEL EUROSARE L BK037 SSP294OSE EUROSARE R BK037 SSP294OSEL EUROSARE L</p> <p>BK037 MOL294C EUROCARBIDE share 18" R BK037 MOL294CL EUROCARBIDE share 18" L</p>
---	--

## Landsides

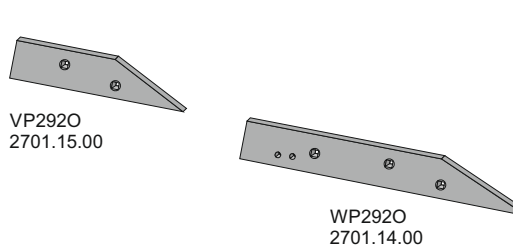

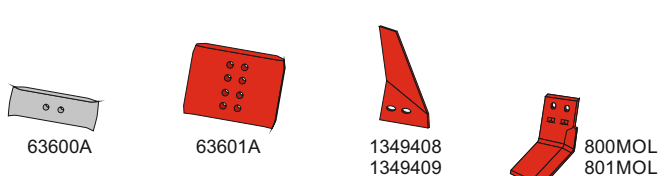

 <p>VP2920 2701.15.00</p> <p>WP2920 2701.14.00</p>	<p>BK033 VP2920 Landside, short R&amp;L BK040 WP2920 Landside, long R&amp;L</p>
---	---

## Parts to mount on landsides

 <p>63600A</p> <p>63601A</p> <p>1349408 1349409</p> <p>800MOL 801MOL</p>	<p>BK094 63600A Wearing plate, rev. R&amp;L BK094 63601A Wearing plate, rev. R&amp;L BK052 1349408 Sword coulter R BK052 1349409 Sword coulter L BK096 800MOL Subsoiler blade R BK096 801MOL Subsoiler blade L</p>
---	--

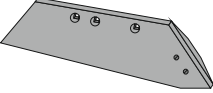
Parts to fit:

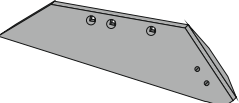
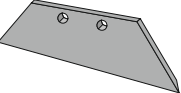
## RABEWERK universal wearing parts

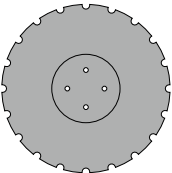
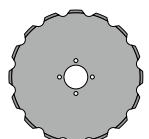
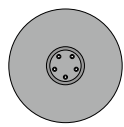
	<u>Bolt box no.</u>	<u>Article-no.</u>	<u>Designation</u>
<b>Shares and points</b>			
SSP332OSE 2708.27.02 SSP332OSEL 2708.27.02			
	BK037	SSP332OSE	EUROSHARE R
	BK037	SSP332OSEL	EUROSHARE L
SSP333OSE 2753.15.01 SSP333OSEL 2753.15.02		MP332 2708.28.01 MP332L 2708.28.02	PK801101R PK801102L
	BK037	SSP333OSE	EUROSHARE R
	BK037	SSP333OSEL	EUROSHARE L
SSP200JB 2708.16.01 SSP200JBL 2708.16.02			
	BK094	MP332	EUROPOINT rev. R
	BK094	MP332L	EUROPOINT rev. L
	BK094	PK801101R	EUROPOINT rev. R
	BK094	PK801102L	EUROPOINT rev. L
<b>Skim shares</b>			
SDG14/16 2742.02.01 SDG14/16L 2742.02.02		SDG181 2715.01.01 SDG181L 2715.01.02	SDG18 2715.05.01 SDG18L 2715.05.02
	BK003	SDG14/16	Skim share R
	BK003	SDG14/16L	Skim share L
	BK001	SDG181	Skim share R
	BK001	SDG181L	Skim share L
	BK001	SDG18	Skim share R
	BK001	SDG18L	Skim share L
<b>Disc coulters</b>			
			
9031.13.29	9008.55.10	9022.52.11	
		9031.13.29	Disc coulters, notched Ø445mm
		9022.52.11	Disc coulters, notched Ø355mm
		9008.55.10	Disc coulters, Ø300mm

**Did you know...**

*that all Mølbros discs are produced in boron steel quality.*

Parts to fit:

# RABEWERK universal ploughbody (Lemken)

Mouldboards, shins and accessories		Bolt box no.	Article-no.	Designation
	571MOL	BK009	3470860	Turbo-trashboard R
		BK009	3470861	Turbo-trashboard L
			4691MOLR	Stay with support R
			4691MOLL	Stay with support L
			571MOL	Support for stay, short
			572MOL	Support for stay, long
		BK007	3451002	Shin R (10mm)
		BK007	3451003	Shin L (10mm)
		BK010	3451010	Shin R (8mm)
		BK010	3451011	Shin L (8mm)
		BK006	3444110	Mouldboard stripe R
		BK006	3444111	Mouldboard stripe L
		BK172	3444120	Mouldboard stripe R
		BK172	3444121	Mouldboard stripe L
	BK172	3444130	Mouldboard stripe R	
	BK172	3444131	Mouldboard stripe L	
	BK173	3444140	Mouldboard stripe R	
	BK173	3444141	Mouldboard stripe L	
	BK140	2101002	Frog R	
	BK140	2101003	Frog L	
Shares and points		Bolt box no.	Article-no.	Designation
	3352010	BK032	3365540	EUROPOINT rev. R
	3352011	BK032	3365541	EUROPOINT rev. L
		BK036	3364050	EUROPOINT R
		BK036	3364051	EUROPOINT L
		BK036	3364150	EUROCARBIDE M5 point R
		BK036	3364151	EUROCARBIDE M5 point L
		BK036	3352010	EUROSHARE 14" R
		BK036	3352011	EUROSHARE 14" L
		BK036	3352020	EUROSHARE 16" R
		BK036	3352021	EUROSHARE 16" L
		BK036	3352030	EUROSHARE 18" R
		BK036	3352031	EUROSHARE 18" L
		BK037	3352034	EUROSHARE 20" R
		BK037	3352035	EUROSHARE 20" L
		BK037	3352134	EUROSHARE 20" R (11mm)
		BK037	3352135	EUROSHARE 20" L (11mm)
		BK036	MOL4150	M7-Adapter R
		BK036	MOL4151	M7-Adapter L
		MOL83	M7 point	
		4879058	Wedge for M7 point	
		4879056	Wedge for M7 point	
	BK039	MOL2034C	EUROCARBIDE share 20" R	
	BK039	MOL2035C	EUROCARBIDE share 20" L	
	BK037	3352234	EUROCARBIDE M5 20" R	
	BK037	3352235	EUROCARBIDE M5 20" L	
Landsides and share knives		Bolt box no.	Article-no.	Designation
	3411460	BK008	3401900AK10	Landside, front R
		BK008	3401901AK10	Landside, front L
		BK036	3411500	Landside, short R&L
		BK036	3411504	Landside, long R&L
		BK037	3411508	Landside, tall R&L
		BK037	3411460	Landside, tall R&L
		BK003	3492890	Share knife R
		BK003	3492891	Share knife L
Parts to mount on landsides		Bolt box no.	Article-no.	Designation
	63600A	BK094	63600A	Wearing plate, rev. R&L
	63601A	BK094	63601A	Wearing plate, rev. R&L
		BK052	1349408	Sword coulter R
		BK052	1349409	Sword coulter L
		BK096	800MOL	Subsoiler blade R
		BK096	801MOL	Subsoiler blade L



Parts to fit

## ROSS/Roudnice nad Labem ploughs

**Bolt box no. Article no. Designation**

### Mouldboards, shins and accessories

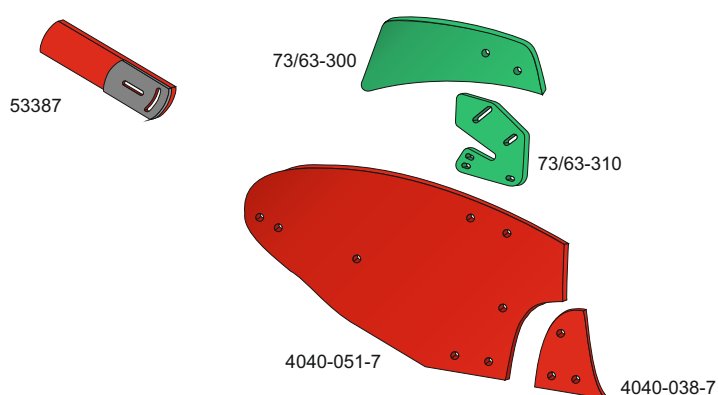

	73/63-300	Turbo-trashboard R
	73/63-310	Fittings for trashboard R
	4040-051-7	Mouldboard R
BK082	53387	Mouldboard extension R
BK058	4040-038-7	Shin R

### Shares, points and accessories

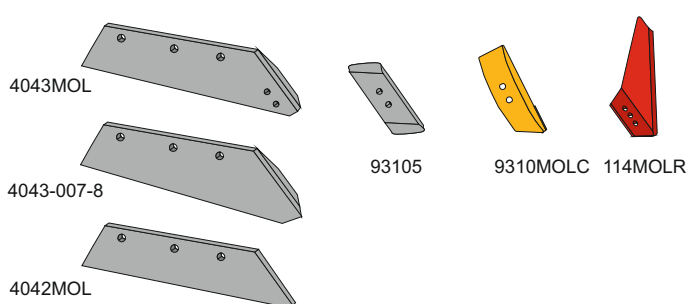

BK037	4043MOL	EUROSHARE R
BK037	4043-007-8	EUROSHARE R
BK037	4042MOL	Share R
BK094	93105	EUROPOINT, rev. R
BK095	9310MOLC	EUROCARBIDE M3 point R
	114MOLR	Share knife R

### Landsides

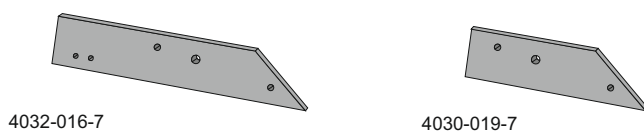

4032-016-7	Landside, long R
4030-019-7	Landside, short R

### Parts to mount on landsides

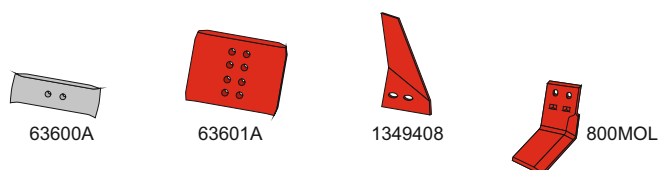

BK094	63600A	Wearing plate, rev. R&L
BK094	63601A	Wearing plate, rev. R&L
BK052	1349408	Sword coulter R
BK096	800MOL	Subsoiler blade R



Parts to fit  
**UNIA ploughs**

**Bolt box no.   Article no.   Designation**

*Shares, points and accessories*

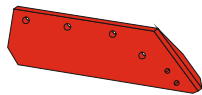

VIS 09  
 VIS 017



C0125  
 C0126

BK038  
 BK038

VIS 09  
 VIS 017

EUROSHARE R  
 EUROSHARE L

BK094  
 BK094

C0125  
 C0126

EUROPOINT R  
 EUROPOINT L

*Landsides*

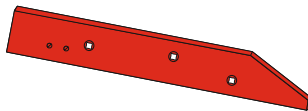

VIS 024  
 VIS 023

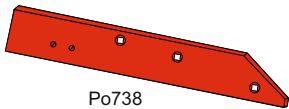

Po738  
 Po739

VIS 024  
 VIS 023

Landside R  
 Landside L

Po 738  
 Po 739

Landside R  
 Landside L

*Parts to mount on landsides*

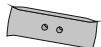

63600A

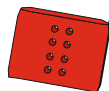

63601A



1349408

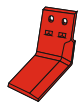

800MOL

BK094  
 BK094  
 BK052  
 BK096

63600A  
 63601A  
 1349408  
 800MOL

Wearing plate, rev. R&L  
 Wearing plate, rev. R&L  
 Sword coulter R  
 Subsoiler blade R



Parts to fit:

## VOGEL & NOOT ploughbody UN 400

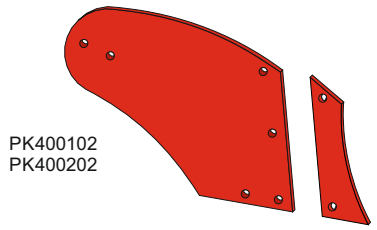
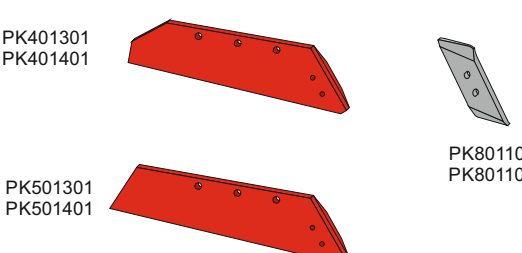
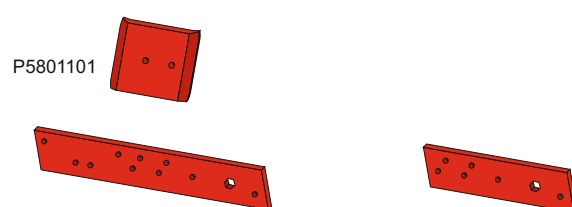
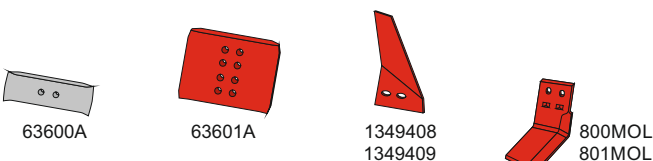
		<u>Bolt box no.</u>	<u>Article-no.</u>	<u>Designation</u>
<b>Mouldboard and shin</b>				
 <p>PK400102 PK400202</p> <p>PK400103 PK400203</p>			PK400102	Mouldboard R
			PK400202	Mouldboard L
		BK021	PK400103	Shin R
		BK021	PK400203	Shin L
<b>Shares and points</b>				
 <p>PK401301 PK401401</p> <p>PK501301 PK501401</p> <p>PK801101R PK801102L</p>		BK112	PK401301	EUROSHARE 16" R
		BK112	PK401401	EUROSHARE 16" L
		BK112	PK501301	EUROSHARE 18" R
		BK112	PK501401	EUROSHARE 18" L
	BK094	PK801101R	EUROPOINT, rev. R	
	BK094	PK801102L	EUROPOINT, rev. L	
<b>Landsides</b>				
 <p>P5801101</p> <p>P8903601 P8903701</p> <p>P8903401 P8903501</p>			P5801101	Wearing plate R&L
			P8903401	Landside, short R
			P8903501	Landside, short L
			P8903701	Landside, long L
<b>Parts to mount on landsides</b>				
 <p>63600A</p> <p>63601A</p> <p>1349408 1349409</p> <p>800MOL 801MOL</p>		BK094	63600A	Wearing plate, rev. R&L
		BK094	63601A	Wearing plate, rev. R&L
		BK052	1349408	Sword coulter R
		BK052	1349409	Sword coulter L
		BK096	800MOL	Subsoiler blade R
		BK096	801MOL	Subsoiler blade L

Parts to fit:

## VOGEL & NOOT ploughs

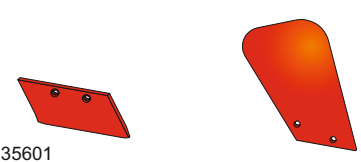
		<u>Bolt box no.</u>	<u>Article-no.</u>	<u>Designation</u>
<b>Skim shares</b>				
 <p>LZ135601 LZ135701</p> <p>PA305402 PA305502</p>		BK069	LZ135601	Skim share R
		BK069	LZ135701	Skim share L
		BK026	PA305402	Skim mouldboard R
		BK026	PA305502	Skim mouldboard L



Parts to fit:

# VOGEL & NOOT ploughbody WY 400

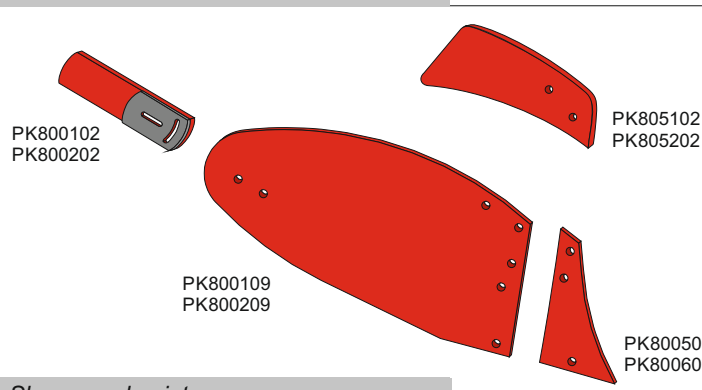
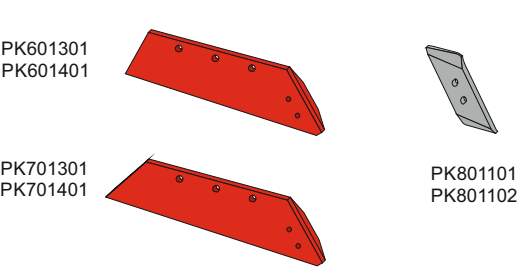
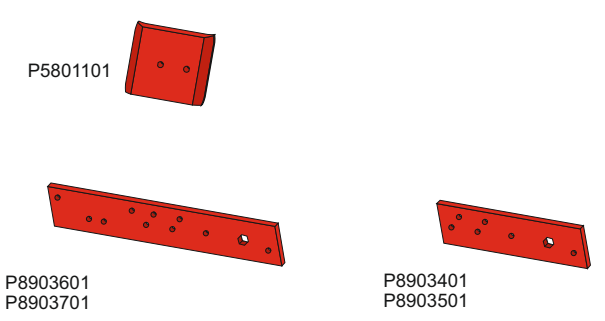
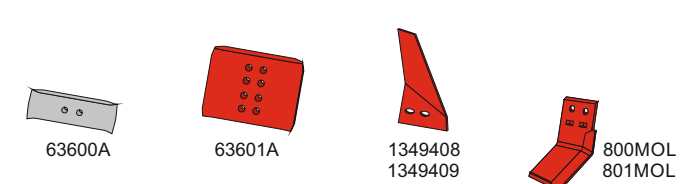
		<u>Bolt box no.</u>	<u>Article-no.</u>	<u>Designation</u>	
<b>Mouldboard, shins and accessories</b>					
 <p>PK800102 PK800202</p> <p>PK800109 PK800209</p> <p>PK805102 PK805202</p> <p>PK800501 PK800601</p>		<i>BK024</i>	PK800109	Mouldboard R	
		<i>BK024</i>	PK800209	Mouldboard L	
		<i>BK022</i>	PK800501	Shin R	
		<i>BK022</i>	PK800601	Shin L	
		<i>BK167</i>	PK805102	Turbo-trashboard R	
		<i>BK167</i>	PK805202	Turbo-trashboard L	
			PK800102	Mouldboard extension R	
			PK800202	Mouldboard extension L	
<b>Shares and points</b>					
 <p>PK601301 PK601401</p> <p>PK701301 PK701401</p> <p>PK801101 PK801102</p>		<i>BK112</i>	PK601301	EUROSHARE 14" R	
		<i>BK112</i>	PK601401	EUROSHARE 14" L	
		<i>BK112</i>	PK701301	EUROSHARE 16" R	
		<i>BK112</i>	PK701401	EUROSHARE 16" L	
		<i>BK094</i>	PK801101R	EUROPOINT, rev. R	
		<i>BK094</i>	PK801102L	EUROPOINT, rev. L	
	<b>Landsides</b>				
	 <p>P5801101</p> <p>P8903601 P8903701</p> <p>P8903401 P8903501</p>		P5801101		Wearing plate, rev. R&L
		P8903401		Landside, short R	
		P8903501		Landside, short L	
		P8903601		Landside, long R	
		P8903701		Landside, long L	
<b>Parts to mount on landsides</b>					
 <p>63600A</p> <p>63601A</p> <p>1349408 1349409</p> <p>800MOL 801MOL</p>		<i>BK094</i>	63600A	Wearing plate, rev. R&L	
		<i>BK094</i>	63601A	Wearing plate, rev. R&L	
		<i>BK052</i>	1349408	Sword coulter R	
		<i>BK052</i>	1349409	Sword coulter L	
		<i>BK096</i>	800MOL	Subsoiler blade R	
		<i>BK096</i>	801MOL	Subsoiler blade L	

Parts to fit  
**ØVERUM SR ploughbody**

**Bolt box no. Article-no. Designation**

**Mouldboard, shin and accessories**

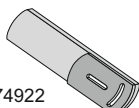
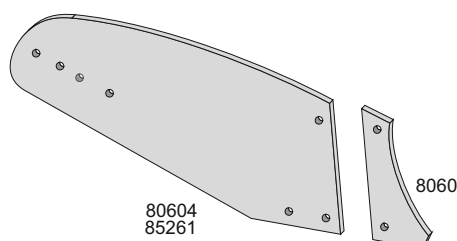
 74922	 80604 85261 80609	<table border="0"> <tr> <td>BK060</td> <td>80604/85261</td> <td>Mouldboard R</td> </tr> <tr> <td>BK082</td> <td>74922</td> <td>Mouldboard extension R</td> </tr> <tr> <td>BK139</td> <td>80609</td> <td>Shin R</td> </tr> </table>	BK060	80604/85261	Mouldboard R	BK082	74922	Mouldboard extension R	BK139	80609	Shin R
BK060	80604/85261	Mouldboard R									
BK082	74922	Mouldboard extension R									
BK139	80609	Shin R									



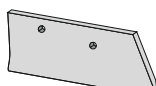
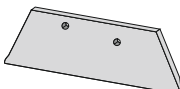
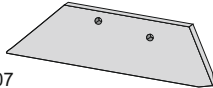
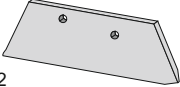
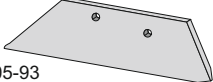
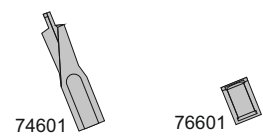

**Shares and points**

 74605	 74606	 74607	 80605-92	 80605-93	 74601 76601	<table border="0"> <tr> <td>BK119</td> <td>74605</td> <td>EUROSHARE 12" R</td> </tr> <tr> <td>BK119</td> <td>74606</td> <td>EUROSHARE 14" R</td> </tr> <tr> <td>BK119</td> <td>74607</td> <td>EUROSHARE 16" R</td> </tr> <tr> <td>BK050</td> <td>80605-92</td> <td>EUROSHARE 14" R</td> </tr> <tr> <td>BK050</td> <td>80605-93</td> <td>EUROSHARE 16" R</td> </tr> <tr> <td></td> <td>74601</td> <td>Point, steel casting R</td> </tr> <tr> <td></td> <td>76601</td> <td>Weld-on point R</td> </tr> </table>	BK119	74605	EUROSHARE 12" R	BK119	74606	EUROSHARE 14" R	BK119	74607	EUROSHARE 16" R	BK050	80605-92	EUROSHARE 14" R	BK050	80605-93	EUROSHARE 16" R		74601	Point, steel casting R		76601	Weld-on point R
BK119	74605	EUROSHARE 12" R																									
BK119	74606	EUROSHARE 14" R																									
BK119	74607	EUROSHARE 16" R																									
BK050	80605-92	EUROSHARE 14" R																									
BK050	80605-93	EUROSHARE 16" R																									
	74601	Point, steel casting R																									
	76601	Weld-on point R																									

**Landsides**

 84239	 74612 74602	<table border="0"> <tr> <td>BK138</td> <td>84239</td> <td>Landside, short R</td> </tr> <tr> <td>BK122</td> <td>74612</td> <td>Wearing plate, rev. R&amp;L</td> </tr> <tr> <td>BK130</td> <td>74602</td> <td>Landside, front R</td> </tr> </table>	BK138	84239	Landside, short R	BK122	74612	Wearing plate, rev. R&L	BK130	74602	Landside, front R
BK138	84239	Landside, short R									
BK122	74612	Wearing plate, rev. R&L									
BK130	74602	Landside, front R									

**Parts to mount on landsides**

 63600A	 63601A	 1349408	 800MOL	<table border="0"> <tr> <td>BK094</td> <td>63600A</td> <td>Wearing plate, rev. R&amp;L</td> </tr> <tr> <td>BK094</td> <td>63601A</td> <td>Wearing plate, rev. R&amp;L</td> </tr> <tr> <td>BK052</td> <td>1349408</td> <td>Sword coulter R</td> </tr> <tr> <td>BK096</td> <td>800MOL</td> <td>Subsoiler blade R</td> </tr> </table>	BK094	63600A	Wearing plate, rev. R&L	BK094	63601A	Wearing plate, rev. R&L	BK052	1349408	Sword coulter R	BK096	800MOL	Subsoiler blade R
BK094	63600A	Wearing plate, rev. R&L														
BK094	63601A	Wearing plate, rev. R&L														
BK052	1349408	Sword coulter R														
BK096	800MOL	Subsoiler blade R														



Parts to fit:

# ØVERUM UC ploughbody

	<u>Bolt box no.</u>	<u>Articel-no.</u>	<u>Designation</u>	
<b>Mouldboard, shin and accessories</b>				
	BK167	83969	Turbo-trashboard R	
	BK167	83968	Turbo-trashboard L	
		84022	Fittings for trashboard R	
		84023	Fittings for trashboard L	
	BK082	74922	Mouldboard extension R	
	BK082	80559	Mouldboard extension L	
	BK062	84031	Mouldboard R	
	BK062	84087	Mouldboard L	
	BK065	84033	Shin R	
	BK065	84082	Shin L	
<b>Shares and points</b>				
	BK087	92206	EUROPOINT, rev. R	
	BK087	92207	EUROPOINT, rev. L	
		92206C	EUROCARBIDE M3 point R	
		92207C	EUROCARBIDE M3 point L	
	BK054	84958	Support R	
	BK054	85191	Support L	
	BK052	85004	EUROSHARE 16" R	
	BK052	85194	EUROSHARE 16" L	
	BK052	85039	EUROSHARE 18" R	
	BK052	85195	EUROSHARE 18" L	
<b>Landsides and share knives</b>				
	BK074	83981	Landside, short R	
	BK074	85196	Landside, short L	
	BK074	85118-94286	Landside, long R	
	BK074	85197-94287	Landside, long L	
	BK084	94622	Share knife R	
	BK084	94623	Share knife L	
	<b>Parts to mount on Landsides</b>			
		BK094	63600A	Wearing plate, rev. R&L
BK094		63601A	Wearing plate, rev. R&L	
BK052		1349408	Sword coulter R	
BK052		1349409	Sword coulter L	
BK096		800MOL	Subsoiler blade R	
BK096		801MOL	Subsoiler blade L	

## Did you know...

that the carbide coating is always on the backside of Mølbros EUROCARBID points. This gives the point a self-sharpening effect so it always attacks the ground optimal - even if it is almost worn.



Parts to fit:

# ØVERUM V ploughbody

	<u>Bolt box no.</u>	<u>Article-no.</u>	<u>Designation</u>
<b>Mouldboards, shins and accessories</b>			
	BK167	83969	Turbo-trashboard R
	BK167	83968	Turbo-trashboard L
		84022	Fittings for trashboard R
		84023	Fittings for trashboard L
	BK082	74922	Mouldboard extension R
	BK082	80559	Mouldboard extension L
	BK062	84031	Mouldboard R
	BK062	84087	Mouldboard L
	BK065	84033	Shin R
	BK065	84082	Shin L
	BK064	85261	Mouldboard R
	BK064	85262	Mouldboard L
	BK065	83980	Shin R
	BK065	84083	Shin L
<b>Shares and points</b>			
	BK069	92206	EUROPOINT, rev. R
	BK069	92207	EUROPOINT, rev. L
	BK069	92206C	EUROCARBIDE M3 point R
	BK069	92207C	EUROCARBIDE M3 point L
	BK055	84288	Support R
	BK055	84289	Support L
	BK052	85383	EUROSHARE 16" R
	BK052	85381	EUROSHARE 16" L
	BK052	85384	EUROSHARE 18" R
	BK052	85382	EUROSHARE 18" L
	BK031	MOL288	M7-Adapter R
	BK031	MOL289	M7-Adapter L
		MOL83	M7 point rev. R/L
		4879058	Wegde for M7 point
		4879056	Wegde for M7point
<b>Landsides and share knives</b>			
	BK074	83981	Landside, short R
	BK074	85196	Landside, short L
	BK074	85118-94286	Landside, long R
	BK074	85197-94287	Landside, long L
	BK084	94622	Share knife R
	BK084	94623	Share knife L
<b>Parts to mount on landsides</b>			
	BK094	63600A	Wearing plate, rev. R&L
	BK094	63601A	Wearing plate, rev. R&L
	BK052	1349408	Sword coulter R
	BK052	1349409	Sword coulter L
	BK096	800MOL	Subsoiler blade R
	BK096	801MOL	Subsoiler blade L



Parts to fit:

# ØVERUM XL ploughbody

	<u>Bolt box no.</u>	<u>Article-no.</u>	<u>Designation</u>
<b>Mouldboards, shins and accessories</b>			
	BK167	83969	Turbo-trashboard R
	BK167	83968	Turbo-trashboard L
	BK082	94624	Fittings for trashboard R
	BK082	94625	Fittings for trashboard L
	BK082	74922	Mouldboard extension R
	BK082	80559	Mouldboard extension L
	BK066	94594	Mouldboard R
	BK066	94595	Mouldboard L
	BK052	94596	Shin R
	BK052	94597	Shin L
<b>Shares and points</b>			
	BK086	94608	EUROPOINT, rev. R
	BK086	94609	EUROPOINT, rev. L
	BK069	94608C	EUROCARBIDE M3 point R
	BK069	94609C	EUROCARBIDE M3 point L
	BK069	94612	Support R
	BK069	94613	Support L
	BK031	MOL612	M7-Adapter R
	BK031	MOL613	M7-Adapter L
		MOL83	M7 point rev. R/L
		4879058	Wedge for M7 point
		4879056	Wedge for M7point
	BK052	94598	EUROSHARE 14" R
	BK052	94599	EUROSHARE 14" L
	BK052	94600	EUROSHARE 16" R
	BK052	94601	EUROSHARE 16" L
	BK052	94602	EUROSHARE 18" R
	BK052	94603	EUROSHARE 18" L
<b>Landsides and share knives</b>			
	Bk074	94604	Landside R
	BK074	94605	Landside L
	BK084	94622	Share knife R
	BK084	94623	Share knife L
<b>Parts to mount on landsides</b>			
	BK094	63600A	Wearing plate, rev. R&L
	BK094	63601A	Wearing plate, rev. R&L
	BK052	1349408	Sword coulter R
	BK052	1349409	Sword coulter L
	BK096	800MOL	Subsoiler blade R
	BK096	801MOL	Subsoiler blade L



Parts to fit:

# ØVERUM XS ploughbody

	<b>Bolt box no.</b>	<b>Article-no.</b>	<b>Designation</b>
<b>Mouldboards and shins</b>			
	BK058	20249	Mouldboard stripe R
	BK058	20894	Mouldboard stripe L
	BK052	20250	Mouldboard stripe R
	BK052	20895	Mouldboard stripe L
	BK052	20251	Mouldboard stripe R
	BK052	20896	Mouldboard stripe L
	BK058	20252	Mouldboard stripe R
	BK058	20897	Mouldboard stripe L
	BK052	21470	Shin R
	BK052	21599	Shin L
<b>Shares and points</b>			
	BK086	94608	EUROPOINT, rev. R
	BK086	94609	EUROPOINT, rev. L
	BK069	94608C	EUROCARBIDE M3 point R
	BK069	94609C	EUROCARBIDE M3 point L
	BK069	94612	Support R
	BK069	94613	Support L
	BK052	96090	EUROSHARE 16" R
	BK052	96091	EUROSHARE 16" L
	BK052	96092	EUROSHARE 18" R
	BK052	96093	EUROSHARE 18" L
	BK031	MOL612	M7-Adapter R
	BK031	MOL613	M7-Adapter L
		MOL83	M7 point rev. R/L
		4879058	Wedge for M7 point
		4879056	Wedge for M7point
<b>Landsides and share knives</b>			
	BK069	96094	Landside R
	BK069	96095	Landside L
	BK084	94622	Share knife R
	BK084	94623	Share knife L
<b>Parts to mount on landsides</b>			
	BK094	63600A	Wearing plate, rev. R&L
	BK094	63601A	Wearing plate, rev. R&L
	BK052	1349408	Sword coulter R
	BK052	1349409	Sword coulter L
	BK096	800MOL	Subsoiler blade R
	BK096	801MOL	Subsoiler blade L









Parts to fit:

# ØVERUM XU ploughbody

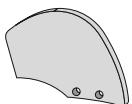
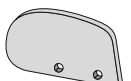
	<b>Bolt box no.</b>	<b>Articel-no.</b>	<b>Designation</b>
<b>Mouldboard, shin and accessories</b>			
	BK167	83968	Turbo-trashboard R
	BK167	83969	Turbo-trashboard L
	BK082	94624	Fittings for trashboard R
	BK082	94625	Fittings for trashboard L
	BK082	74922	Mouldboard extension R
	BK082	80559	Mouldboard extension L
	BK067	96084	Mouldboard R
	BK067	96085	Mouldboard L
	BK052	96086	Shin R
	BK052	96087	Shin L
<b>Shares and points</b>			
	BK069	94608	EUROPOINT, rev. R
	BK069	94609	EUROPOINT, rev. L
	BK069	94608C	EUROCARBIDE M3 point R
	BK069	94609C	EUROCARBIDE M3 point L
	BK069	94612	Bracket plate R
	BK069	94613	Bracket plate L
	BK031	MOL612	M7-Adapter R
	BK031	MOL613	M7-Adapter L
		MOL83	M7 point rev. R/L
		4879058	Wegde for M7 point
		4879056	Wegde for M7point
	BK052	96090	EUROSHARE 16" R
	BK052	96091	EUROSHARE 16" L
	BK052	96092	EUROSHARE 18" R
	BK052	96093	EUROSHARE 18" L
<b>Landsides and share knives</b>			
	BK069	96094	Landside R
	BK069	96095	Landside L
	BK084	94622	Share knife R
	BK084	94623	Share knife L
<b>Parts to mount on landsides</b>			
	BK094	63600A	Wearing plate, rev. R&L
	BK094	63601A	Wearing plate, rev. R&L
	BK052	1349408	Sword coulter R
	BK052	1349409	Sword coulter L
	BK096	800MOL	Subsoiler blade R
	BK096	801MOL	Subsoiler blade L

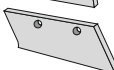
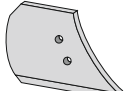
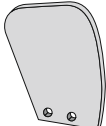
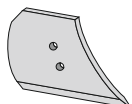
Parts to fit:

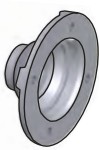
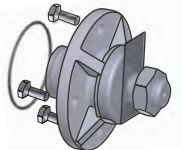
## ØVERUM ploughs

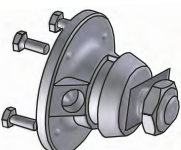
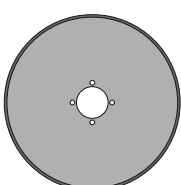
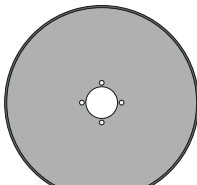
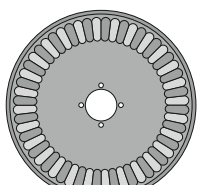
		<u>Bolt box no.</u>	<u>Article-no.</u>	<u>Designation</u>
<b>Skim shares and skim mouldboards</b>				
		BK003	80645	Skim mouldboard R
80645	91803	BK052	91803	Skim mouldboard R
		BK052	91804	Skim mouldboard L
80644	91801	BK052	95509	Skim mouldboard R
	91802	BK052	95510	Skim mouldboard L
		BK008	81519	Skim share R
81519	95509	BK001	86322	Skim share R
	95510	BK001	86323	Skim share L
		BK050	80644	Skim share R
86322	93055	BK052	91801	Skim share R
86323	93054	BK052	91802	Skim share L
		BK052	93055	Skim share R
		BK052	93054	Skim share L
<b>Disc coulters</b>				
		73249		Cover for disc coulters R&L
73249	73242A	80966		Cover for disc coulters R&L
		73242A		Hub disc coulters R&L
80966	80967AH	80967AH		Hub disc coulters M30R
	80967AV	80967AV		Hub disc coulters M30L
		72547		Disc coulters 18" R&L
72547	80662	80662		Disc coulters 20" R&L
		80663		Disc coulters, rippled 20" R&L

Parts to fit:

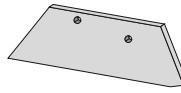
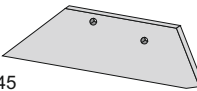

## ØVERUM SM, SML and SMK ploughbodies

		<u>Bolt box no.</u>	<u>Article-no.</u>	<u>Designation</u>
<b>Shares and points</b>				
		BK122	72633	Share 14" R
72633		BK122	71345	Share 16" R
			76601	Weld-on point R
71345			72635	Point, steel casting R

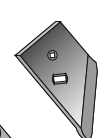
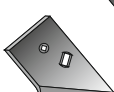
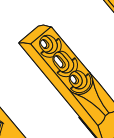

Parts to fit:

## KVERNELAND Subsoiler "S" model AGROMAT

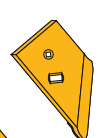
	<u>Bolt box no.</u>	<u>Article-no.</u>	<u>Designation</u>
<b>Wings and points</b>			
		217001320	Rev. point
		217001402L	EUROCARBIDE point
	BK044	217001402R	Wing R, wide
	BK044	217001320C	Wing L, wide
	BK044	217001402RC	Wing R, carbide coated
	BK044	217001402LC	Wing L, carbide coated





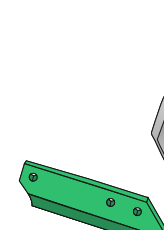
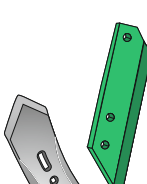
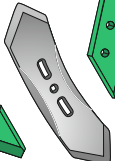



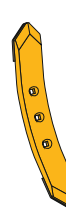

Parts to fit:

## KVERNELAND Bonator

<b>Wings and points</b>			
	BK099	131124R	Wing R
	BK099	131125R	Wing L
	BK034	337MOL	Rev. point 12 x 120 x 455

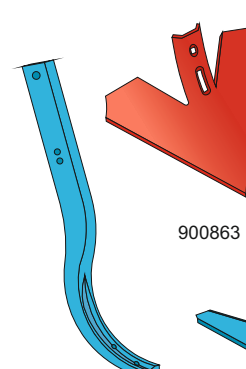

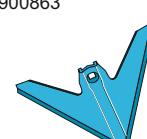



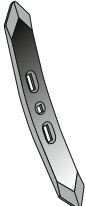

Parts to fit:

## Standard Harrows and Subsoiler

<b>Shares and points</b>			
	BK046	506008	Rev. point, 16 x 60 x 495
	BK046	506008-20	Rev. point, 20 x 60 x 495
	BK046	506008C	EUROCARBIDE point rev, 16 x 60 x 495
	BK046	506009	Rev. point, 15 x 55 x 410
	BK046	506009C	EUROCARBIDE point rev, 15 x 55 x 410
	BK046	506009-20	Rev. point, 13 x 55 x 410
	BK047	900863	Duck foot point, 460mm
	BK047	901MOL	Duck foot point, 310mm
	BK160	6TGL	EUROPOINT, rev. 6 x 40 x 210
		4041003057	Duck foot point, 252mm
		4878000	Universal beam

Parts to fit:

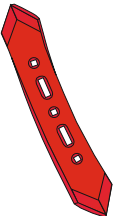
## Standard Harrows and Subsoiler

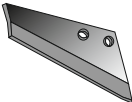
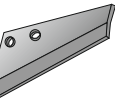
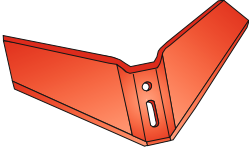
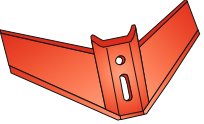
	<u>Bolt box no.</u>	<u>Article-no.</u>	<u>Designation</u>
<b>Wings and points</b>			
	BK034	334MOL	Rev. point, 16 x 60 x 490
	BK034	335MOL	Rev. point, 12 x 80 x 420
	BK034	336MOL	Rev. point, 12 x 100 x 420
	BK034	337MOL	Rev. point, 10 x 120 x 455
	BK034	338MOL	Rev. point, 10 x 130 x 485
	BK034	339MOL	Rev. point, 12 x 100 x 480
		HC121	Point turned R 80 x 12 x 510
		HC122	Point turned L 80 x 12 x 510
	BK021	92536 (506301)	Wing R, 8mm
	BK021	92537 (506302)	Wing L, 8mm
	BK147	500MOL	EUROWING wing 500 x 14 mm
	BK147	320MOL	EUROWING wing 320 x 12mm

Parts to fit:

## US Standard Subsoiler, CASE, NEW HOLLAND

	Nn101583 (33310060)	Wing point, standard 330 x 190 x 30mm
	NN10685	Point, standard 330 x 30mm
	C NELSON	Duck foot point, 200mm
	BN90989	Point 50 x 8mm

Parts to fit:

## Standard Discs for Kverneland, Horsch, Fortschritt etc.

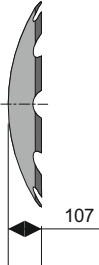
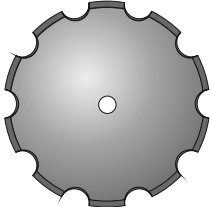
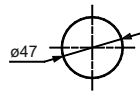
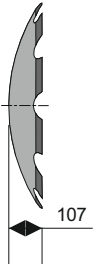
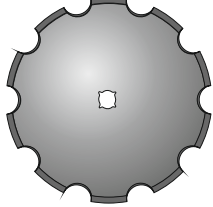
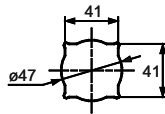
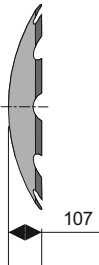
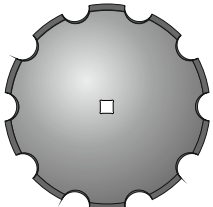
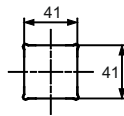
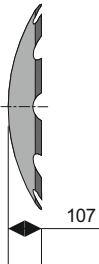
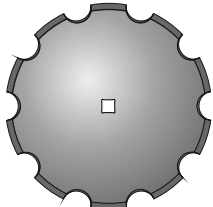
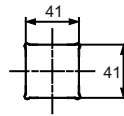
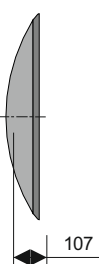
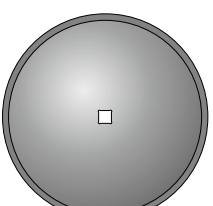
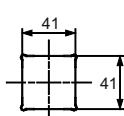
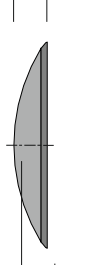
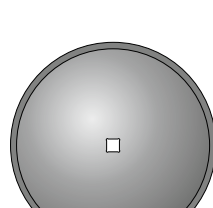
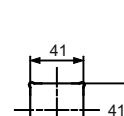
Discs			Article-no.	Designation
			331354271	Disc, notched Ø 660x6 mm <i>fits to:</i> Fortschritt
			MDU1-660	Disc, notched Ø 660x6 mm <i>fits to:</i> Kuhn 117109 Väderstad 406938 (Ø42) Vogel & Noot DSQ06609 (Ø41)
			MDU3-660-6	Disc, notched Ø 660x6 mm <i>fits to:</i> Dalbo 72387 (41x41) Rabe 64423202 (30x30) Kverneland KK121220R (40x40)
			MDU3-660-8	Disc, notched Ø 660x8 mm <i>fits to:</i> Dalbo 72387 (41x41) Rabe 64423202 (30x30) Kverneland KK121220R (40x40)
			MDU4-660-6	Disc Ø 660x6 mm <i>fits to:</i> Dalbo 72387 (41x41) Rabe 64423202 (30x30) Kverneland KK121220R (40x40) Rau Rf28474
			MDU4-660-8	Disc Ø 660x8 mm <i>fits to:</i> Dalbo 72387 (41x41) Rabe 64423202 (30x30) Kverneland KK121220R (40x40) Rau Rf28474

Should you require a particular share hole in your 660 mm disc, please let us have details, and we will quote according.

Parts to fit:

## Standard Discs for Kverneland, Horsch, Fortschritt etc.

Discs

			Article-no.	Designation
	<p>MDU5-660-6</p>		MDU5-660-6	Disc Ø 660x6 mm <i>fits to:</i>  Kuhn 117109 Väderstad 406938 (Ø42) Vogel & Noot DSQ06609 (Ø41)
	<p>MDU4-610-6</p>		MDU4-610-6	Disc Ø 610x6 mm
	<p>MDU4-510-6</p>		MDU4-510-6	Disc Ø 510x6 mm <i>fits to:</i>  Dalbo 72388 (41x41)

Should you require a particular share hole in your 660 mm disc, please let us have details, and we will quote according.

Parts to fit:

## Hub for disc coulters (Kverneland DXG etc.)

	02/0551301	Spacer th- 230-42x42
	05/0558340	Steel bearing shell 42x42
	50/0551315	Convex flange 42x42
	50/0551314	Convex flange 42x42

















Parts to fit:

# HORSCH Subsoiler and Standard Subsoiler

**Bolt box no. Article-no. Designation**

*Guide boards and points*







					
34060858	34060859	34060862	34060863	<i>BK147</i> 34060859	Guideboard R
				<i>BK147</i> 34060858	Guideboard L
				<i>BK147</i> 34060863	Guideboard R
				<i>BK147</i> 34060862	Guideboard L
				<i>BK147</i> 34182600	Side guideboard L
34182600	34182700			<i>BK147</i> 34182700	Side guideboard R
				34060855	Wing R
				34060854	Wing L
				34060857	Wing R
34060857	34060856	34060857C	34060856C	34060856	Wing L
				34060857C	EUROCARBIDE Wing R
				34060856C	EUROCARBIDE Wing L
				<i>BK148</i> 34060850	EUROPOINT 80x12
34060850	34060850-15	00310915		<i>BK148</i> 34060850-15	EUROPOINT 80x15
				<i>BK148</i> 00310915	EUROPOINT 80x15
				<i>BK148</i> 34060850C	EUROCARBIDE point 80x12
				<i>BK148</i> 34060850C-15	EUROCARBIDE point 80x15
34060850C	34060850C-15	00310915C		<i>BK148</i> 00310915C	EUROCARBIDE point 80x15
				<i>BK148</i> MBL00311069	EUROPOINT with tiles 80x20
				MLB00311069-2	EUROPOINT with tiles - 2 holes 80x20
MLB00311069	MLB00311069-2				



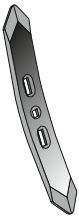

Parts to fit:

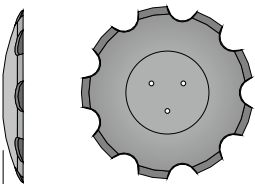
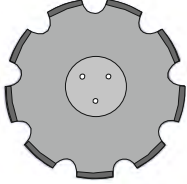
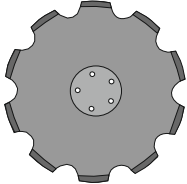
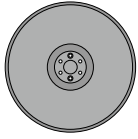
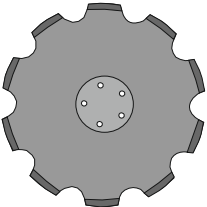

## HORSCH Subsoiler and Standard Subsoiler

	<u>Bolt box no.</u>	<u>Article-no.</u>	<u>Designation</u>
<b>Points</b>			
		334MOL	Rev. point, 16 x 60 x 490
		335MOL	Rev. Point, 12 x 80 x 420
		336MOL	Rev. point, 12 x 100 x 420
		337MOL	Rev. point, 10 x 120 x 455
		338MOL	Rev. point, 10 x 130 x 485
		339MOL	Rev. point, 12 x 100 x 480
	BK034	334MOL	
	BK034	335MOL	
	BK034	336MOL	
	BK034	337MOL	
	BK034	338MOL	
	BK034	339MOL	

	<u>Article-no.</u>	<u>Designation</u>
<b>Disc coulters</b>		
	23246106	Disc coulters, concave, notched Ø455mm
	23246102	Disc coulters, concave, notched Ø460mm
	28071304	Disc coulters, concave, notched Ø460mm
	23010201	Disc coulters, flat, Ø345mm
	28071305	Disc coulters, concave, notched Ø520mm

Parts to fit:

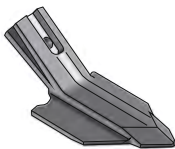
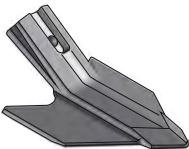
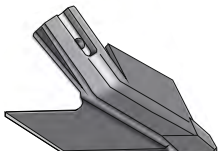
## BOURGAULT Subsoiler

	<u>Article-no.</u>	<u>Designation</u>
<b>Points</b>		
	MB-200-057	Point, 57mm
	MB-200-100	Point, 100mm
	MB-200-140	Point, 140mm
	MB-200-180	Point, 180mm
	MB-200-230	Point, 230mm
	MB-200-255	Point, 255mm

Parts to fit:

## KERNER Subsoiler

**Bolt box no. Article-no. Designation**

*Guide boards and points*

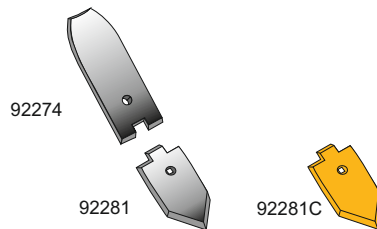

BK049	92274	Guideboard center
BK162	92281	EUROPOINT, 12x120x240
BK162	92281C	EUROCARBIDE point, 12 x 120 x 240

Parts to fit:

## KÖCKERLING Subsoiler and Standard Subsoiler

*Guide boards, wings and points*

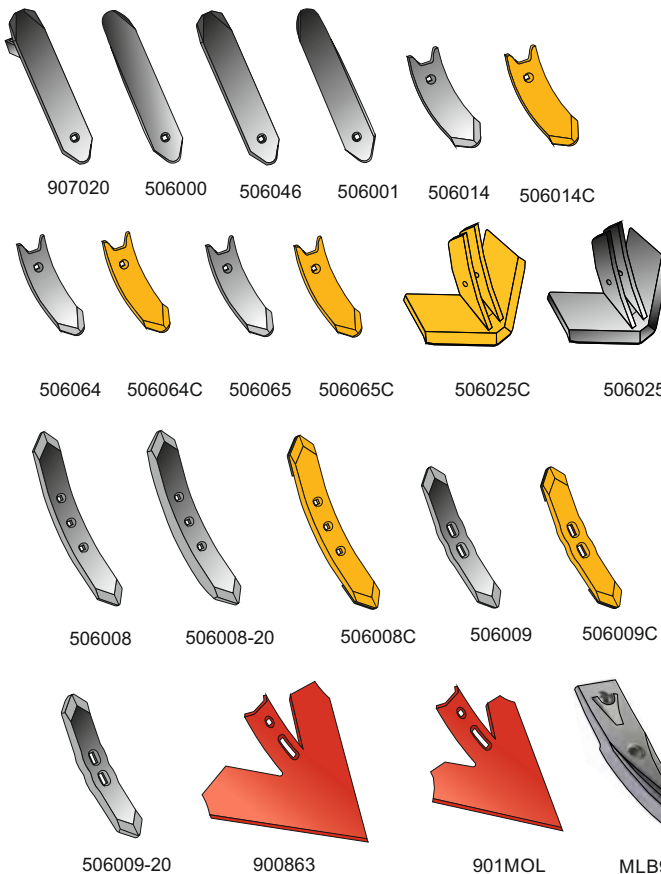









BK148	907020	Guideboard center, with safety catch
BK148	506000	Guideboard R
BK148	506001	Guideboard L
BK148	506046	Guideboard center
BK148	506014	EUROPOINT, 12 x 100 x 288
BK148	506014C	EUROCARBIDE point, 12 x 100 x 288
BK148	506064	EUROPOINT, 12 x 80 x 288
BK148	506065	EUROPOINT, 14 x 80 x 288
BK148	506065C	EUROCARBIDE point, 14 x 80 x 288
	506025C	EUROCARBIDE wing, 350mm
	506025	Wing, 350mm
BK046	506008	EUROPOINT, rev, 16 x 60 x 495
BK046	506008C	EUROCARBIDE point rev, 16 x 60 x 495
BK046	506008-20	EUROPOINT, rev, 20 x 60 x 495
BK046	506009	EUROPOINT, rev, 15 x 55 x 410
BK046	506009C	EUROCARBIDE point rev, 16 x 60 x 495
BK047	900863	Duck foot point, 460mm
BK047	901MOL	Duck foot point, 310mm
	MLB915776	EUROPOINT with tiles 80x20mm

### Did you know that...

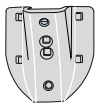
Mølbros produce the guideboard 907020 with an open safety hook so you don't have to remove the point to change the guideboard.

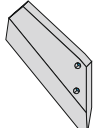

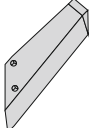
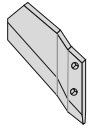
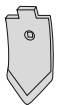
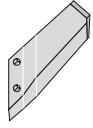
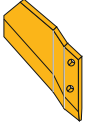
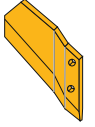

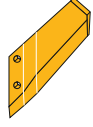
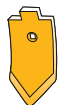



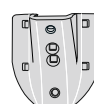

Parts to fit:

## LEMKEN Smaragd / Topas Harrows

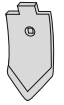
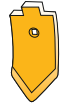
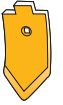
Wings, points and accessories				Bolt box no.	Article-no.	Designation
				BK048	4679105	Foot - Stein 10
3374398	3374395	4679105	3374399	BK049	3374398	Guide board outer R
				BK049	3374395	Guide board center
	3374416	3374388	3374417	BK049	3374399	Guide board outer L
				BK088	3374416	Wing 10 mm R
	3374418	3374388-12	3374419	BK088	3374417	Wing 10 mm L
	3374420		3374421	BK088	3374418	Wing, Curved 10 mm R
				BK088	3374419	Wing, Curved 10 mm L
	3374424C-12	3374424C-15	3374392C	BK088	3374420	Wing, Curved 11 mm R
				BK088	3374421	Wing, Curved 11 mm L
				BK088	3374424C-15	Wing, Curved, carbide R
				BK088	3374425C-15	Wing, Curved, carbide L
				BK035	3374388	EUROPOINT 120x10
				BK035	3374388-12	EUROPOINT 120x12
				BK035	3374392C	EUROCARBIDE point 120x12
				BK035	3374392-15C	EUROCARBIDE point 120x15
						
		3374392-15C				

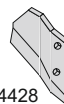
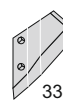
Parts to fit:

## LEMKEN Thorit / Achat Harrows

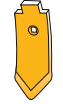
Wings, points and accessories				Bolt box no.	Article-no.	Designation
				BK049	3374398	Guide board outer R
3374398	3374395	4679105	3374399	BK049	3374395	Guide board center
				BK048	4679105	Guide board center
	3374388	3374388-12	3374392C	BK049	3374399	Guide board outer L
				BK035	3374388	EUROPOINT 120x10
				BK035	3374388-12	EUROPOINT 120x12
				BK035	3374392C	EUROCARBIDE point 120x12
				BK035	3374392-15C	EUROCARBIDE point 120x15
				BK088	3374428C	Wing, Curved, carbide R
	3374428C	3374428	3374429	BK088	3374428	Wing, Curved, R
				BK088	3374429	Wing, Curved, L
				BK088	3374429C	Wing, Curved, carbide L
				BK049	3374401	Guide board center
	3374401	4679107	3374386	BK048	4679107	Foot
				BK035	3374386	EUROPOINT 80x12
				BK035	3374386C	EUROCARBIDE point 80x12

Parts to fit:

## LEMKEN Kristall / Karat Harrows

Guide boards, wings and points

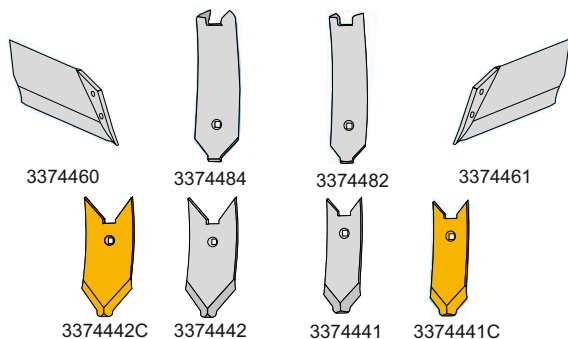

**Bolt box no. Article-no. Designation**

BK174	3374484	Guideboard center 100x8
BK174	3374482	Guideboard center 80x8
BK174	3374442	EUROPOINT 120x10
BK174	3374441	EUROPOINT 80x14
BK174	3374442C	EUROCARBIDE point 120x10
BK174	3374441C	EUROCARBIDE point 80x14
BK174	3374460	Wing R
BK174	3374461	Wing L

Parts to fit:

## LEMKEN Harrows

Points and disc coulters

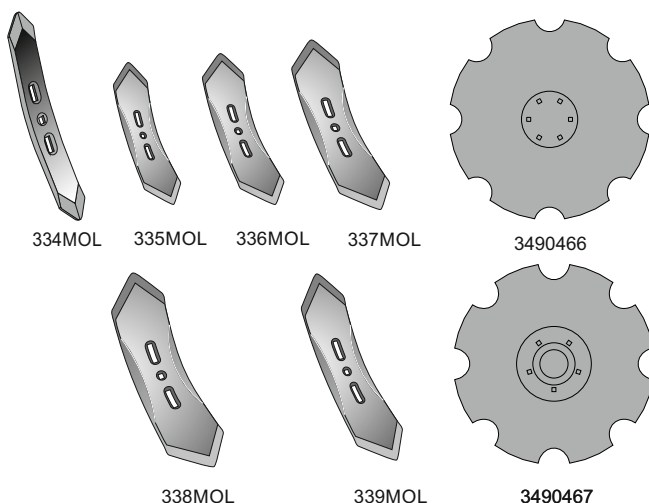

BK034	334MOL	Rev. Point 16 x 60 x 490
BK034	335MOL	Rev. point, 12 x 80 x 420
BK034	336MOL	Rev. Point, 12 x 100 x 420
BK034	337MOL	Rev. point, 10 x 120 x 455
BK034	338MOL	Rev. point, 10 x 130 x 485
BK034	339MOL	Rev. point, 12 x 100 x 480
	3490466	Disc coulters, concave, notched Ø625mm
	3490467	Disc coulters, concave, notched Ø625mm

Parts to fit:

## LEMKEN KOMPAKTOR Harrows

Points

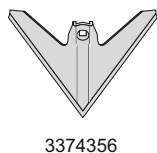

BK017	3374356	Duck foot point 250 x 5
-------	---------	----------------------------

Parts to fit:

## LEMKEN-Drill machines



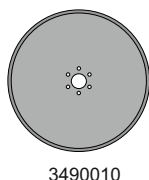





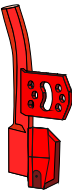

Seeding

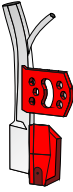
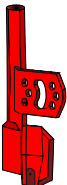
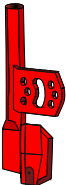
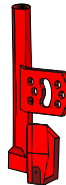
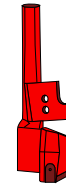
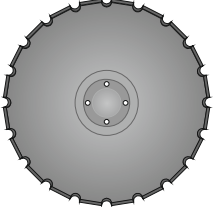
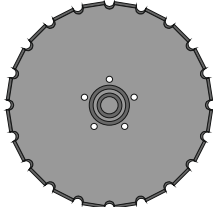
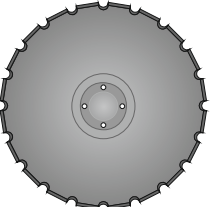
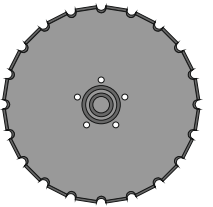
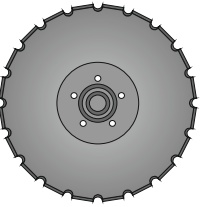
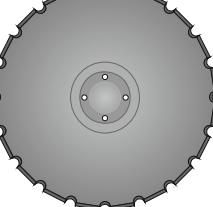

	3490010	Seeding Disc, flat Ø350mm
--	---------	------------------------------

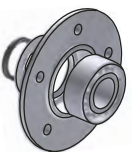
Parts to fit:

## VÄDERSTAD Drill machines

		<u>Bolt box no.</u>	<u>Article-no.</u>	<u>Designation</u>
<b>Fertilizing</b>				
			432120 432121 432120MOL-SF 432121MOL-SF 432120MOL-SLF 432121MOL-SLF	Seed share, fertilizer R Seed share, fertilizer L Seed share, fertilizer R Stainless steel Seed share, fertilizer L Stainless steel Combo seed share, liquid fertilizer R, Stainless steel Combo seed share, liquid fertilizer R, Stainless steel
432120 432121	432120MOL-SF 432121MOL-SF	432120MOL-SLF 432121MOL-SLF		
<b>Seeding</b>				
				432117 432116 499059 499060 432119 432118 307108 307107
432117 432116	499059 499060	432119 432118	307108 307107	Seed share R Seed share L Bean share Bean share Seed share R, short slit Seed share L, short slit Seed share R Seed share L
				444687 (423787) 451793 459608
444687/423787	451793	459608		Disc coulter, concave, notched Ø432mm Disc coulter, notched Ø370mm Disc coulter, concave, notched Ø432mm
				451371 451372 466947
451371	451372	466947		Disc coulter, notched Ø410mm Disc coulter, concave, notched Ø410mm Disc coulter, concave, notched Ø450mm
				473585 473586 BK088 419998-1 BK088 419998-1C BK088 419999-1 BK023 302300 BK160 6TGL
473586 473585		419998-1	419998-1C	Leveling disc L, Ø430mm Leveling disc R, Ø430mm Wearing plate 45x10 Wearing plate 45x10 Wearing plate 80x8 Rev. point
				400703 420832 482496 152271-1 152271-2
420832	482496	152271-1	152271-2	Hub for disc coulter Hub for disc coulter with hub cover to fit Ø 30mm axle Hub for disc coulter with hub cover to fit Ø 47mm axle

Parts to fit:

## VÄDERSTAD Harrows

<i>Wings, points and accessories</i>		<b>Bolt box no.</b>	<b>Article-no.</b>	<b>Designation</b>			
			<i>BK148</i> 452956 <i>BK148</i> 461309 <i>BK148</i> 452957	Guide board R Guide board L Guide board center			
				<i>BK048</i> 457618 <i>BK048</i> 452854 <i>BK048</i> 457618C <i>BK048</i> 452854C	Point 50x12 Point 80x12 EUROCARBIDE point 50x12 EUROCARBIDE point 80x12		
				155027 155028 447150 447151	EUROPOINT 50x15 EUROPOINT 80x15 Wing R Wing L		
						<i>BK034</i> 334MOL <i>BK034</i> 335MOL <i>BK034</i> 336MOL <i>BK034</i> 337MOL <i>BK034</i> 338MOL <i>BK034</i> 339MOL	Rev. point, 16 x 60 x 490 Rev. point, 12 x 80 x 420 Rev. point, 12 x 100 x 420 Rev. point, 10 x 120 x 455 Rev. point, 10 x 130 x 485 Rev. point, 12 x 100 x 480
				<i>BK044</i> 201388-1 <i>BK044</i> 201387-1 <i>BK046</i> 355652 <i>BK046</i> 355652C 447152	EUROPOINT R 90 x 10 x 460 EUROPOINT L 90 x 10 x 460 EUROPOINT point, rev. 19 x 57 x 460 EUROCARBIDE point, rev. 19 x 57 x 460 EUROPOINT rev. 20 x 50 x 495		

Parts to fit:

## AMAZONE Harrows

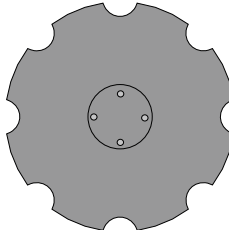
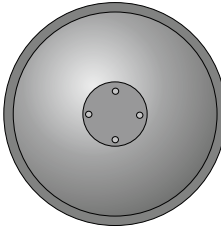
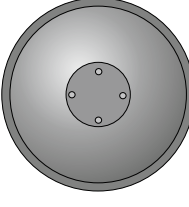
<i>Disc coulters</i>				
			78201966 XL-041 XL-011	Disc coulters, concave, notched Ø 510x4mm Disc coulters, concave, plain Ø 510x4mm Disc coulters, concave, plain Ø 460x4mm

## EUROCARBIDE Wearing parts ploughs

Parts to fit..

### AGROLUX

EUROPOINTS coated

**Bolt box no.** **Article no.** **Designation**

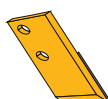

84987C  
85206C

BK031	84987C	EUROCARBIDE M5 point R
BK031	85206C	EUROCARBIDE M5 point L

Parts to fit..

### FORTSCHRITT, FRAUGE

EUROPOINTS coated



9310MOLC



5309MOLC

BK095	9310MOLC	EUROCARBIDE M3 point R
BK095	5309MOLC	EUROCARBIDE M3 point R

Parts to fit..

### GREGORIE-BESSON

EUROPOINTS coated



MOL332C  
MOL331C

BK095	MOL332C	EUROCARBIDE M3 point R
BK095	MOL331C	EUROCARBIDE M3 point L

Parts to fit..

### KUHN

Accessories coated



MOL180C  
MOL181C

BK095	MOL180C	EUROCARBIDE M3 point R
BK095	MOL181C	EUROCARBIDE M3 point L

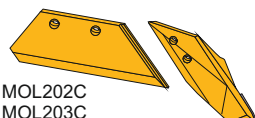

MOL202C  
MOL203C

MOL200C  
MOL201C

BK166	MOL200C	EUROCARBIDE M5 point R
BK166	MOL201C	EUROCARBIDE M5 point L

BK165	MOL202C	EUROCARBIDE M5 share 16" R
BK165	MOL203C	EUROCARBIDE M5 share 16" L

### Did you know...

*Mølbros uses a special developed and specified powder wire, which is welded on with six-axis welding robots to ensure maximum precision and uniformity.*

## EUROCARBIDE Wearing parts ploughs

Parts to fit..

### KVERNELAND ploughbodies no. 6,7,8,9, 28

EUROPOINT M5 coated

Bolt box no. Article no. Designation

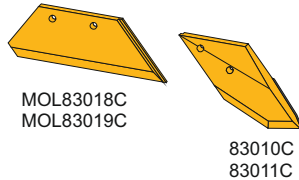

BK144 83010C EUROCARBIDE M5 point R  
BK144 83011C EUROCARBIDE M5 point L

BK111 MOL83018C EUROCARBIDE M5 16" R  
BK111 MOL83019C EUROCARBIDE M5 16" L

EUROCARBIDE, EUROPOINTS coated

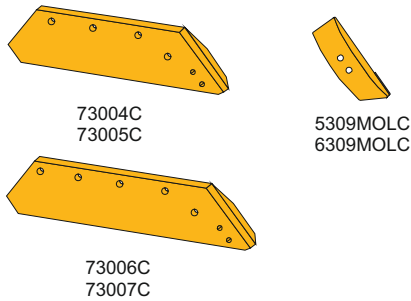

BK113 073004C EUROCARBIDE share 16" R  
BK113 073005C EUROCARBIDE share 16" L

BK114 073006C EUROCARBIDE share 18" R  
BK114 073007C EUROCARBIDE share 18" L

BK095 5309MOLC EUROCARBIDE M3 point R  
BK095 6309MOLC EUROCARBIDE M3 point L

Landsides coated

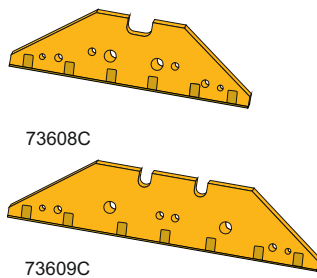

BK111 73608C EUROCARBIDE,landside,short R&L

BK111 73609C EUROCARBIDE,landside,long R&L

Parts to fit..

### KVERNELAND ploughbodies no. 12,19 & 20,30

EUROSHARE M5 coated

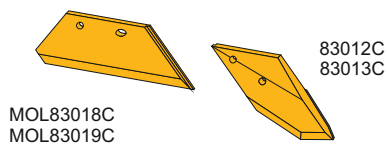

BK170 MOL83018C EUROCARBID M5 share 16" R  
BK170 MOL83019C EUROCARBID M5 share 16" L

BK144 83012C EUROCARBID M5 point R  
BK144 83013C EUROCARBID M5 point L



## EUROCARBIDE Wearing parts ploughs

Parts to fit..

**LEMKEN**

Accessories coated

Bolt box no. Article no. Designation

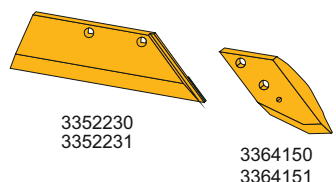

BK031 3352230 EUROCARBIDE M5 18" R  
BK031 3352231 EUROCARBIDE M5 18" L

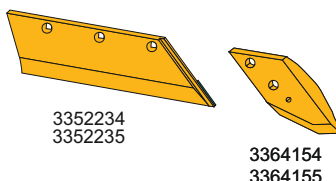

BK036 3364150 EUROCARBIDE M5 point R  
BK036 3364151 EUROCARBIDE M5 point L  
BK036 3364154 EUROCARBIDE M5 point R  
BK036 3364155 EUROCARBIDE M5 point L

BK037 3352234 EUROCARBIDE M5 20" R  
BK037 3352235 EUROCARBIDE M5 20" L

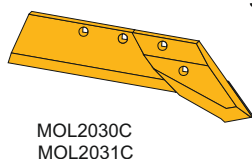

BK038 MOL2030C EUROCARBIDE share 18" R  
BK038 MOL2031C EUROCARBIDE share 18" L

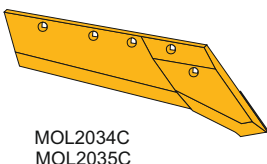

BK039 MOL2034C EUROCARBIDE share 20" R  
BK039 MOL2035C EUROCARBIDE share 20" L

### **Did you know...**

*that the carbide coating is cohesively connected with the base material which ensures optimal durability of the coating. This means that the coating cannot fall of - it can only be worn down.*



## EUROCARBIDE Wearing parts ploughs

Parts to fit..  
**MASSEY-FERGUSON**

Accessories coated

Bolt box no. Article no. Designation

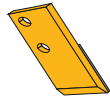

84987C  
85206C

BK031 84987C EUROCARBIDE M5 point R  
BK031 85206C EUROCARBIDE M5 point L

Parts to fit..  
**RABE**

Accessories coated

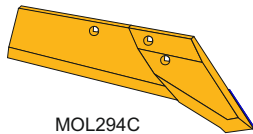

MOL294C  
MOL294CL

BK037 MOL294C EUROCARBIDE share 18" R  
BK037 MOL294CL EUROCARBIDE share 18" L

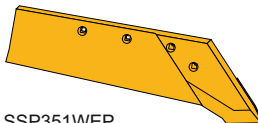

SSP351WEP  
SSP351WEPL



MOL350C  
MOL350LC

BK095 MOL350C EUROCARBIDE M3 point R  
BK095 MOL350CL EUROCARBIDE M3 point L

BK038 SSP351WEP EUROCARBIDE share R  
BK038 SSP351WEPL EUROCARBIDE share L

Parts to fit..  
**ØVERUM**

Accessories coated



92206C  
92207C



84060C  
85143C



94608C  
94609C

BK069 92206C EUROCARBIDE M3 point R  
BK069 92207C EUROCARBIDE M3 point L  
BK069 84060C EUROCARBIDE M3 point R  
Bk069 85143C EUROCARBIDE M3 point L  
BK069 94608C EUROCARBIDE M3 point R  
BK069 94609C EUROCARBIDE M3 point L



## EUROCARBIDE Wearing parts, and subsoilers

Parts to fit.  
**HORSCH**

Wings and Points coated

Bolt box no. Article no. Designation

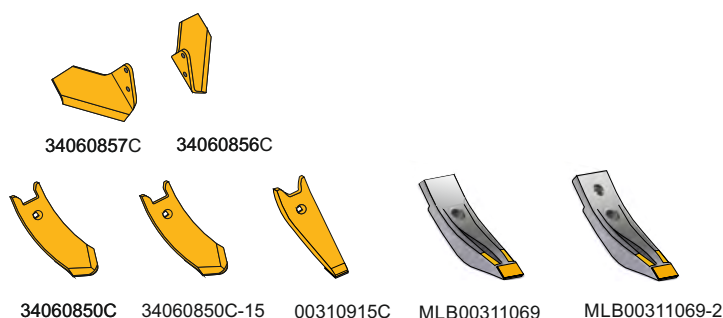

	34060857C	Wing, coated R
	34060856C	Wing, coated L
<i>BK148</i>	34060850C	EUROCARBIDE point 85 x 12
<i>BK148</i>	34060850C-15	EUROCARBIDE point 15mm 85 x 15
<i>BK148</i>	00130915C	EUROCARBIDE point 15mm 85 x 15
<i>BK014</i>	342MOL	EUROCARBIDE point
<i>BK148</i>	MLB00311069	EUROPOINT with tiles 80x20
	MLB00311069-2	EUROPOINT with tiles - 2 holes 80x20

Parts to fit.  
**KERNER**

Points coated



<i>BK162</i>	92281C	EUROCARBIDE point 12 x 120 x 240
--------------	--------	-------------------------------------

Parts to fit.  
**KVERNELAND**

Wings and Points coated

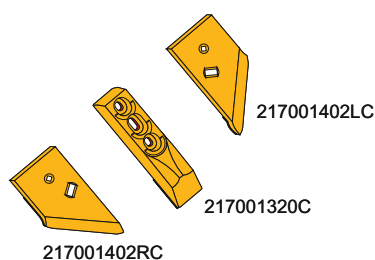

	217001320C	EUROCARBIDE point
<i>BK044</i>	217001402C	Wing R
<i>BK044</i>	217001402LC	Wing L

Parts to fit.  
**KÖCKERLING**

Points coated

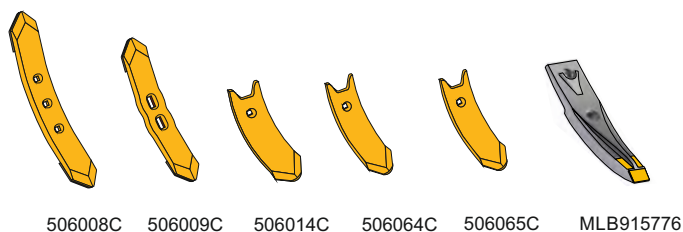

<i>BK046</i>	506008C	EUROCARBIDE point, rev, 16 x 60 x 495
<i>BK046</i>	506009C	EUROCARBIDE point, rev, 15 x 55 x 410
<i>BK148</i>	506014C	EUROCARBIDE point, 12 x 100 x 288.
<i>BK148</i>	506064C	EUROCARBIDE point, 12 x 80 x 288.
<i>BK148</i>	506065C	EUROCARBIDE point, 14 x 80 x 288.
	MLB915776	EUROPOINT with tiles 80x20mm

## EUROCARBIDE Wearing parts subsoiler

Parts to fit.

### LEMKEN

Wings and Points coated

**Bolt box no.** **Article no.** **Designation**

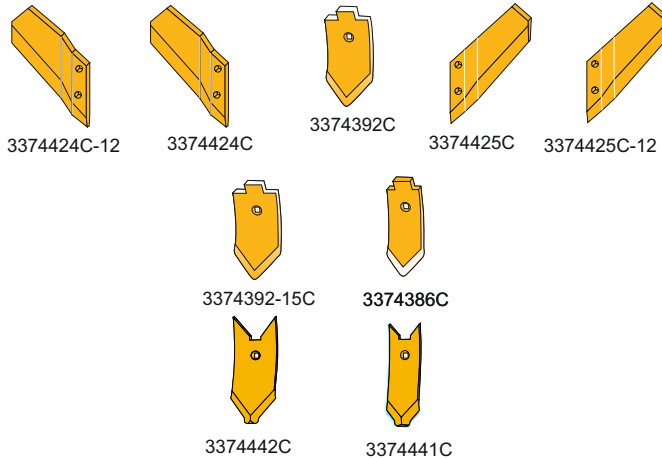

BK088 3374424C    Wing Curved, coated R  
BK088 3374425C    Wing Curved, coated L

3374424C-12    Wing Curved, coated R  
3374425C-12    Wing Curved, coated L

BK174 3374392C    EUROCARBIDE point 12mm

BK174 3374392-15C    EUROCARBIDE point 15mm

BK174 3374442C    EUROCARBIDE point 120x10

BK174 3374386C    EUROCARBIDE point

BK174 3374441C    EUROCARBIDE point 80x14

Parts to fit.

### Standard

Points coated



BK046 506008C    EUROCARBIDE point, rev,  
16 x 60 x 495

BK046 506009C    EUROCARBIDE point, rev,  
15 x 55 x 410

BK046 355652C    EUROCARBIDE point, rev,  
19 x 57 x 460

Parts to fit.

### Väderstad

Points coated

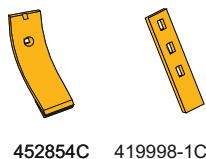

BK048 452854C    EUROCARBID spids, 80x12

BK088 419998-1C    Wearing plate 45x10

## Disc coulters and accessories

Parts to fit:

**KVERNELAND**

Disc coulters and accessories

Article-no.    Designation

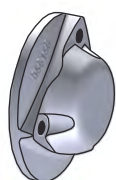

56156

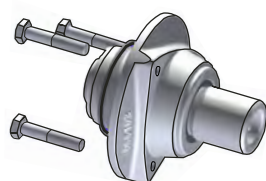

60609

56156  
60609

Universal cover for hub  
Hub disc coulters Ø34mm  
(complete)

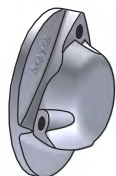

56156

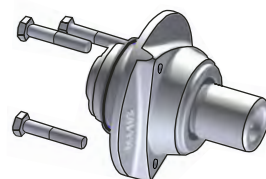

60624

56156  
60624

Universal cover for hub  
Hub disc coulters Ø30mm  
(complete)



56156

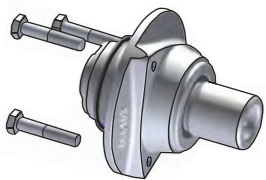

60609CA

56156  
60609CA

Universal cover for hub  
Hub disc coulters Ø30mm  
(complete)

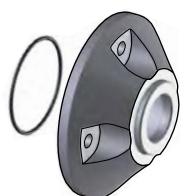

86100

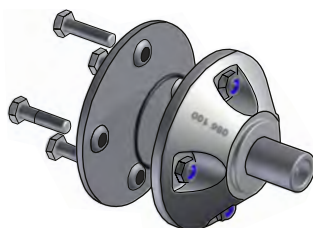

86087R

86100

Hub for disc coulters  
(without axle)

86087R

Hub disc coulters (complete)

## Disc coulters and accessories

Parts to fit:

### VÄDERSTAD

Disc coulters and accessories

		Article-no.	Designation
	420832	420832	Hub for disc coulters
	482496	482496 (BAA0003)	Hub for disc coulters
	152271-1	152271-1 (BAA0003A)	Hub for disc coulters with hub cover to fit Ø 30mm axle
	152271-2	152271-2 (BAA0003A)	Hub for disc coulters with hub cover to fit Ø 47mm axle

Parts to fit:

### ÖVERUM

Disc coulters and accessories

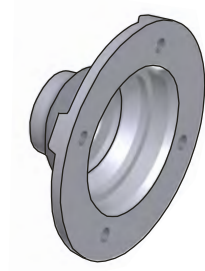
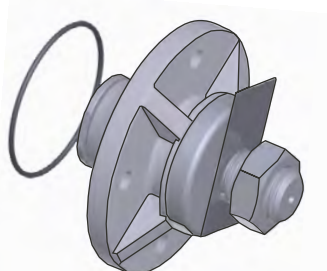
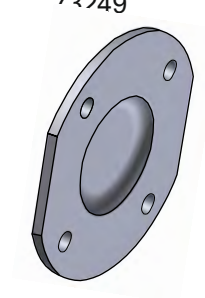
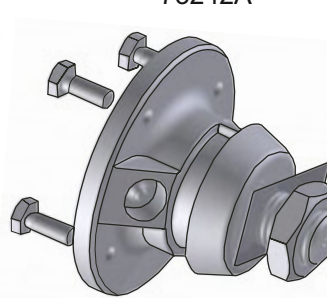
	73249	73249	Cover for hub
	73242A	73242A	Hub for disc coulters 1/8" WGL
	80966	80966	Cover for hub
	80967AH 80967AV	80967AH 80967AV	Hub for disc coulters M30R Hub for disc coulters M30L

## MØLBRO's bolts and nuts BK-System

---

<u>BK-no.</u>	<u>Bolt bags pr. Box</u>	<u>BK-no.</u>	<u>Bolt bags pr. Box</u>	<u>BK-no.</u>	<u>Bolt bags pr. Box</u>
BK001	60	BK052	60	BK112	50
BK003	60	BK053	60	BK113	40
BK004	60	BK054	60	BK114	30
BK005	25	BK055	50	BK116	10
BK006	50	BK056	25	BK118	25
BK007	60	BK057	40	BK119	60
BK008	60	BK058	60	BK121	60
BK009	60	BK059	25	BK122	60
BK010	60	BK060	25	BK123	60
BK011	25	BK062	25	Bk128	40
BK013	50	BK063	25	BK129	25
BK014	40	BK064	25	BK130	25
BK015	60	BK065	60	BK131	50
BK016	60	BK066	25	BK132	25
BK017	60	BK067	25	BK134	30
BK018	25	BK069	60	BK136	50
BK019	25	BK071	20	BK138	25
BK021	60	BK072	35	BK139	50
BK022	60	BK073	25	BK140	10
BK023	50	BK074	25	BK144	35
BK024	20	BK077	50	BK147	50
BK026	50	BK078	50	BK148	50
BK027	50	BK082	60	BK150	50
BK031	60	BK084	60	BK154	15
BK032	60	BK086	60	BK160	1
BK033	50	BK087	60	BK161	25
BK034	40	BK088	60	BK162	60
BK035	60	BK089	60	BK163	50
BK036	60	BK090	50	BK165	50
BK037	50	BK091	50	BK166	50
BK038	40	BK092	40	BK167	60
BK039	35	BK094	60	BK170	50
BK040	40	BK095	60	BK171	25
BK041	60	BK096	60	BK172	50
BK042	50	BK097	60	BK173	50
Bk044	50	BK098	60	BK174	60
Bk045	50	BK099	60		
BK046	60	BK100	50		
BK047	50	BK101	60		
BK048	60	BK103	25		
BK049	60	BK110	25		
BK050	60	BK111	60		

www.molbro.com

[www.molbro.com](http://www.molbro.com)

You can contact Mølbro 24/7

Mølbro A/S is a Danish company which has been developing and producing wearing parts for soil preparation for more than 65 years.

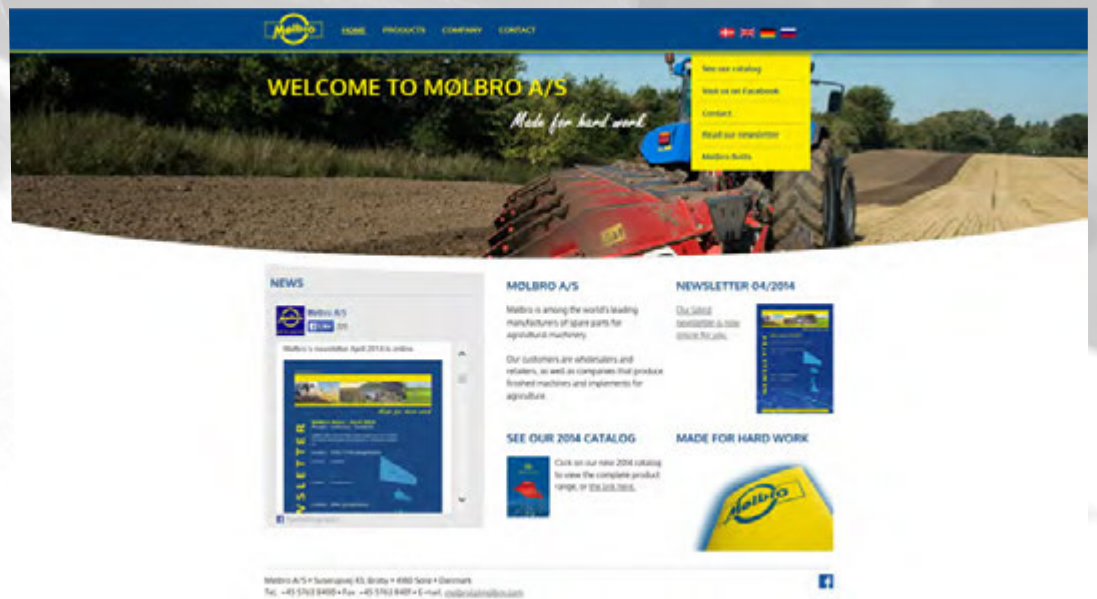

Check out [www.molbro.com](http://www.molbro.com) where you will find news, further information as well as all the benefits of our products.

We look forward to see you on our new homepage.

*Our idea -  
Your success*





# M7 PRODUCTS

## Full range - Made for hard work

**MOL 4150/51**  
to fit Lemken  
B,BS,US

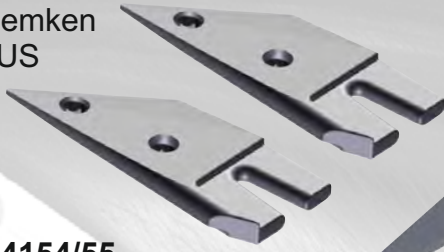

**MOL288/289**  
to fit Øverum V

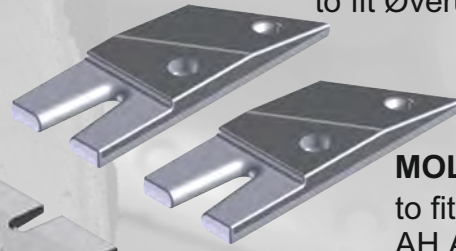

**44879058**  
M7 wedge



**MOL612/613**  
to fit Øverum/Agrolux  
AH,AS,AX,XU,XL

**MOL 4154/55**  
to fit Lemken C,C40



**MOL83-0/-1**  
to fit Kverneland  
6,7,8,9,28

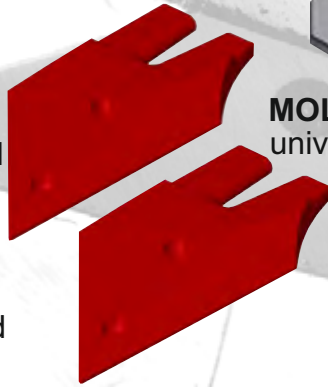

**MOL 83**  
universal fit to all



**MOL 30-0/-1**  
to fit Kuhn SK



**MOL83-2/-3**  
to fit Kverneland  
12,19,20,30

**44879056**  
M7 Pro-wedge

**MOL 20-0/-1**  
to fit Kuhn VL,VS

**MOL 25-0/-1**  
to fit Kuhn H4,H6,

*Our idea -  
Your success*

**NEW**

Change your point - with **ONE STROKE !**

**NEW**





**Would you like to get more information about new products,  
activities and events?  
Sign up for our newsletter at [www.molbro.com](http://www.molbro.com) and follow us on  
[www.facebook.com/molbrodenmark](https://www.facebook.com/molbrodenmark).**





Mølbro A/S  
Suserupvej 43  
4180 Sorø  
Tel. 57 63 84 00  
Fax 57 63 84 01  
molbro@molbro.dk

[molbro.com](http://molbro.com)