



moving forward in every field

LANGUE/LANGUAGE • FR/EN

VALMET

▶▶ **PIÈCES DE TRACTEURS/TRACTOR PARTS**

Catalogue - Première publication 2005

Catalogue - First published 2005

www.bepcoparts.com

Member of **TVH** 

■ À PROPOS DE BEPCO

Le groupe Bepco est un leader mondial dans la fourniture de pièces de rechange, accessoires pour tracteurs et pièces détachées pour machines agricoles.

Avec plus de 360 employés, le groupe Bepco a des filiales en Belgique, France, Pays-Bas, Allemagne, Espagne et Angleterre. Nous sommes aussi présents en Australie, Nouvelle Zélande, Afrique du sud et au Brésil.

Le groupe Bepco est une société mondiale avec des clients dans plus de 100 pays à travers le monde, les ventes hors Europe contribuent à plus d'un tiers du chiffre d'affaires.

Nous proposons à notre réseau de distributeurs et revendeurs :

- ▶ Des fournisseurs d'équipements d'origine et d'autres marques reconnues
- ▶ Plus de 20 000 m² de surface de stockage
- ▶ Plus de 80 000 références en stock
- ▶ Des connaissances techniques d'experts de l'industrie
- ▶ Une expédition le jour même pour une livraison le jour suivant

Le groupe Bepco fait partie du groupe TVH, fournisseur de pièces et accessoires de qualité pour le matériel de manutention, les véhicules industriels et l'équipement agricole.

■ ABOUT BEPCO

Bepco Group is a worldwide leading supplier of parts and accessories for agricultural tractors and machinery.

With over 360 employees Bepco Group has subsidiaries in Belgium, Netherlands, France, Germany, Spain and UK and is also present in Australia, New Zealand, South Africa and Brazil.

Bepco Group is a truly global company with customers in over 100 countries worldwide and sales outside Europe contributing to over a third of revenues.

We offer our network of distributors and dealers :

- ▶▶ Original Equipment Supplier and other industry leading brands
- ▶▶ More than 20,000 m² of warehousing
- ▶▶ More than 80,000 stock items
- ▶▶ Technological knowledge from industry experts
- ▶▶ Same day shipment, next day delivery in many markets

Bepco Group is also a member of TVH, the all-round supplier of quality parts and accessories for material handling, industrial vehicles and agricultural equipment.

VALMET

Rotules & tirants de direction - Steering links & sockets - Stuurkogels en stangen - Kugelgelenke und Spurstangen - Rótulas y acoples de dirección

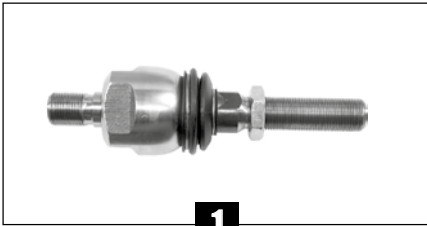

1

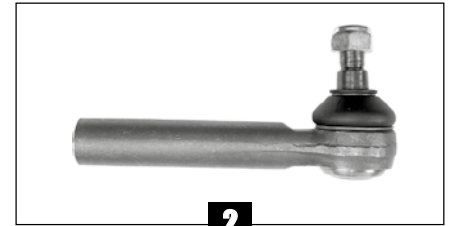



2

	Type	Fig.	Part N°	OEM	Filet Thread Gewinde Schroefdraad Rosca	Longueur Lenght Länge Lengte Longitud	Conicité Cone Konus Conisch Cono
6250HI, 6350HI, 6550HI, 6650HI, 6850HI 8050HI, 8150HI, 8350HI, 8450HI, 8550HI,	Sige	1	41/497-138	31798520	M22x1,5RH M22x1,5RH	210	-
		2	41/495-142	31798600	F22x1,5RH	210	24/26
		2	41/495-148	31882210	F22x1,5RH	293	29/32
	Carraro	1	41/497-139	34051500	M22x1,5RH M24x1,5RH	210	-
		2	41/495-149	34051700	F24x1,5RH	270	24/26
T120, T130, T140, T150, T160, T170, T180, T190	Carraro	1	41/497-139	34051500	M22x1,5RH M24x1,5RH	210	-
		2	41/495-149	34051700	F24x1,5RH	270	24/26
T120, T130, T140, T160, T170, T190	Sige Dana	1	41/497-138	31798520	M22x1,5RH M22x1,5RH	210	-
		2	41/495-142	31798600	F22x1,5RH	210	24/26
T120, T130, T140, T150, T160, T170, T180, T190	Dana 730	1	41/497-138	31798520	M22x1,5RH M22x1,5RH	210	-
		2	41/495-370	35728300	F22x1,5RH	260	24/26
M120, M130, M150	Sige	1	41/497-138	31798520	M22x1,5RH M22x1,5RH	210	-

VALMET PARTS

Pompe hydraulique - Hydraulic pump - Hydraulikpumpe - Hydrauliekpomp - Bomba hidráulica



	Part N°	OEM	Débit Flow Druck Debiet Flujo		Type d'arbre Shaft type Welle type Astyp Tipo de eje	Description Beschreibung Omschrijving Descripción
6250HI, 6350HI, 6550HI, 6650HI, 6750HI, 6850HI 8050HI, 8150HI, 8350HI, 8450HI, 8550HI, 8950HI	69/565-243	33664100	32 + 12	G LH Links Izq.	DIN5480	Double arbre Shaft double Doppeltwelle Dubbeleas Doble eje

Les références des pièces sont indicatives.
Nos pièces ne sont pas d'origine.

Part numbers are quoted for reference purposes only.
Our parts and accessories are not original.







"THE RELIABLE SERVICE"

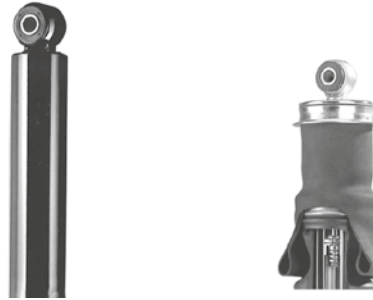

VALTRA PARTS

AMORTISSEURS DE PONT AVANT & CABINE - FRONT AXLE SHOCK ABSORBERS & CAB -
VORDERACHSEDÄMPFER & FAHRERHAUS - VOORASSCHOKDEMPERS & CABINE -
AMORTIGUADORES DE EJE DELANTERO & DE LA CABINA DE CONDUCTOR



	Ref.	OEM	Type de fixation Fastening type Befestigungsarten Verbindingswijze Tipo de fijación	Description Beschreibung Omschrijving Descripción
Série M Series Série T Series	41/4116-10 	35358800	Bossage en haut / Bossage en bas Top eye / Bottom eye Oberes Auge / Untenes Auge Bovenste ring / Onderste ring Anillo superior / Anillo inferior	Bitube pression de gaz Twin-tube, gas pressure Doppelrohr, Gasdruck Dubbelloop / gasdruk Bitubular, presión de gas
Selon applications Some applications Nach Anwendungen Volgens toepassingen según aplicación	41/4115-7 	33139100		

 Essieu avant / Front axle / Vorderachse / Vooraas / Eje delantero

 Cabine / Cab / Kabine / Cabine / Cabina

Les références des pièces sont indicatives.
Nos pièces ne sont pas d'origine.

Part numbers are quoted for reference purposes only.
Our parts and accessories are not original.



VALTRA PARTS

**Pompe à eau - Water pump - Wasserpumpe
Waterpomp - Bomba de agua**



	OEM	Part N°
6250HI, 6350HI, 6550HI, 6650HI, 6850HI (⇒K6490)	836747847	41/130-295

Les références de pièces sont indicatives.
Nos pièces ne sont pas d'origines

Parts numbers are quoted for reference purposes only.
Our parts and accessories are not original





"THE RELIABLE SERVICE"



VALMET PARTS

Arbres de prise de force - PTO shafts - Zapfwellenstummel - Aftakassen - Ejes de TDF

	Ref.	Description Beschreibung Omschrijving Descripción	
6000, 6100, 6200, 6300, 6400, 6600, 6800, 6900, 8000, 8100, 8200, 8400, 6250HI, 6350HI, 6450HI, 6550HI, 6850HI, 8150HI, 8350HI, 8450HI, 8550HI, 8950HI	41/303-106 (31813100)	1 3/8" - 228,6mm - 6 cannelures - 14 dents 1 3/8" - 228,6mm - 6 splines - 14 teeth 1 3/8" - 228,6mm - 6 nuten - 14 zähne 1 3/8" - 228,6mm - 6 tanden - 14 tanden 1 3/8" - 228,6mm - 6 estrías - 14 dientes	
	41/303-109	1 3/4" - 228,6mm - 6 cannelures - 14 dents 1 3/4" - 228,6mm - 6 splines - 14 teeth 1 3/4" - 228,6mm - 6 nuten - 14 zähne 1 3/4" - 228,6mm - 6 tanden - 14 tanden 1 3/4" - 228,6mm - 6 estrías - 14 dientes	

Les références des pièces sont indicatives.
Nos pièces ne sont pas d'origine.

Part numbers are quoted for reference purposes only.
Our parts and accessories are not original.



INDEX INDEX

Air conditionné	51	<i>Air conditioning</i>	51
Alternateurs	49	<i>Alternators</i>	49
Attelage	47, 48	<i>Blinking units</i>	26
Avertisseur sonore	26	<i>Brake cylinders</i>	39
Balais d'essuie-glace	52	<i>Brakes</i>	39, 40
Bouchons de radiateurs	17	<i>Cab filters</i>	25
Bougies de préchauffage	14	<i>Cab glass</i>	53, 54, 55, 56
Câbles	16	<i>Cab heaters</i>	51
Câble d'embrayage	35	<i>Cables</i>	16
Câble de frein à main	40	<i>Clutch assemblies & plates</i>	32, 33, 34
Centrales clignotantes	26	<i>Clutch cable</i>	35
Chauffages de cabine	51	<i>Clutch master and slave cylinders</i>	35
Chemises	9, 10	<i>Crankshaft and related parts</i>	6
Contacteurs	26, 27, 28, 29	<i>Cross references</i>	57, 58
Contacteur de température	19	<i>Dry disc brakes</i>	39, 40
Couronne	6	<i>Engine gaskets</i>	13
Courroies et ventilateur	20	<i>Engine overhaul kits</i>	8
Croisillons	43	<i>Engine seals</i>	7
Cylindres de frein	39	<i>Fan belt and fan blades</i>	20
Démarrateurs	49	<i>Filters</i>	23, 24, 25
Durites de pompe à eau	18	<i>Front axle</i>	42
Échappements	21, 22	<i>Front axle parts</i>	41
Éclairage	30, 31	<i>Fuel pumps</i>	15
Embrayage	32, 33, 34, 35	<i>Gas struts</i>	52
Filtres	23, 24, 25	<i>Handbrake cable</i>	40
Filtres de cabine	25	<i>Heater plugs</i>	14
Freins à disque	39, 40	<i>Horn</i>	26
Goujons et écrous de roue	41	<i>Hydraulic pumps</i>	46
Index des références	59, 60	<i>Independent PTO drives</i>	38
Jeux de révision moteur	8	<i>Injector nozzles</i>	14
Jeux de segments	9, 10	<i>Levelling boxes</i>	47, 48
Joint de pompe à eau	19	<i>Lighting</i>	30, 31
Joints de vérin de direction	43	<i>Liners</i>	9, 10
Joints moteur	7, 13	<i>Mirrors</i>	52
Maître-cylindres et cylindres récepteur d'embrayage	35	<i>Paint</i>	50
Mécanismes & disques d'embrayage	32, 33, 34	<i>Pistons</i>	9, 10
Nez d'injecteur	14	<i>PTO</i>	36
PDF indépendante	38	<i>Radiators</i>	17
Peinture	50	<i>Radiators caps</i>	17
Pièces d'avant-train	41	<i>Reference index</i>	59, 60
Pistons	9, 10	<i>Ring gear</i>	6
Pompes à eau	19	<i>Ring sets</i>	9, 10
Pompes d'alimentation	15	<i>Seats</i>	50
Pompes hydrauliques	46	<i>Silencers</i>	21, 22
Pont avant	42	<i>Sockets</i>	44
Prise de force	36	<i>Starter motors</i>	49
Radiateurs	17	<i>Steering couplings</i>	45
Références interchangeables	57, 58	<i>Steering cylinder gaskets</i>	43
Rétroviseurs	52		

Les références des pièces sont indicatives.
Nos pièces ne sont pas d'origine



"THE RELIABLE SERVICE"



Part numbers are quoted for reference purposes only.
Our parts and accessories are not original.

INDEX INDEX

Rotules et tirants de direction	44	<i>Switches</i>	26, 27, 28, 29
Sièges	50	<i>Temperature switch</i>	19
Soupapes et pièces connexes	11, 12	<i>Thermostats</i>	20
Tableau d'identification des tracteurs et des moteurs	5	<i>Tie rod and sockets</i>	44
Thermostats	20	<i>Tractor and engine application chart</i>	5
Tirants et accouplements de direction	44, 45	<i>Transmission parts</i>	37
Tirants de direction	44, 45	<i>Universal joints</i>	43
Transmission	37	<i>Valves and related parts</i>	11, 12
Vérins à gaz	52	<i>Water pump hoses</i>	18
Vilebrequin et pièces connexes	6	<i>Water pumps</i>	19
Vitrierie de cabine	53, 54, 55, 56	<i>Wheel bolts and nuts</i>	41
		<i>Wiper blades</i>	52

Les références des pièces sont indicatives.
Nos pièces ne sont pas d'origine

*Part numbers are quoted for reference purposes only.
Our parts and accessories are not original.*



TABLEAU D'IDENTIFICATION DES TRACTEURS ET DES MOTEURS
TRACTOR AND ENGINE APPLICATION CHART

Tracteurs Tractors	Moteurs Engines	Cyl. Cyl.	Tracteurs Tractors	Moteurs Engines	Cyl. Cyl.
205	309D	3	6900	620DRE	6
305	309DS	3	6250HI	420DSRE	4
365	320D, DS	3	6350HI	420DSRE	4
405	309DS	3	6550HI	420DWRE	4
465	320DS	3	6650HI	420DWRE	4
505	311DS	3	6850HI	420DWRIE	4
565	320DS	3	8000	620D	6
600	320D	3	8050	620DS	6
605	311DS	3	8050	620DSR	6
665	420DS	4	8100	620D	6
700	320DS	3	8150	620DS	6
700 MKII	411DS	4	8150	620DSR	6
705	411DS	4	8200	634D	6
800	420DR	4	8300	612D	6
805	411DS	4	8300T	612DS	6
865	420DS	4	8400	320DS	6
865S	420DS	4	8450	620DW	6
900	420DRS	4	8450	620DWR	6
900	411DS	4	8550	634DS	6
905	611D	6	8580	634DSR	6
6000	420D	4	8600	612DS	6
6100	320DS	3	8750	634DS	6
6200	420DSRE	4	8050HI	620DSRE	6
6300	420DS	4	8150HI	620DSRE	6
6400	420DS	4	8350HI	634DSRE	6
6400	420DW	4	8450HI	620DWRE	6
6600	420DS	4	8550HI	634DSRE	6
6800	420DSI	4	8950HI	634DSBE	6

Les références des pièces sont indicatives.
 Nos pièces ne sont pas d'origine



"THE RELIABLE SERVICE"



Part numbers are quoted for reference purposes only.
 Our parts and accessories are not original.

Ed. 1 (11/05)

Valmet -5

VILEBREQUIN ET PIÈCES CONNEXES CRANKSHAFT AND RELATED PARTS



		1	2	3	4
Tracteurs Tractors	Moteurs Engines	Paire cous. de palier Main bearing pair	Paire cous. de bielle Conrod bearing pair	Paire d'épaisseurs latérales Thrust washer pair	Bague de bielle Small end bush
205 305, 405	309D 309DS	41/2-300 (836006671)	41/3-300 (836006501)	41/6-300 (836112632)	41/28-300 (836006502)
505, 605 705, 805 905	311DS 411DS 611D				41/28-301 (836110646)
365, 600 365, 465, 565, 700, 6100 700MKII, 900 665, 865, 6300, 6400 800 900 6000 6400 6600 6800 6200, 6250HI, 6350HI 6550HI, 6650HI 6850HI 8000, 8100 8050, 8150, 8400 8050HI, 8150HI 8200 8300 8450 8550, 8750 8600 8350HI, 8550HI 8450HI 8950HI	320D 320DS 411DS 420DS 420DR 420DRS 420D 420DW 420DS 420DSI 420DSRE 420DWRE 420DWRIE 620D 620DS 620DSRE 634D 612D 620DW 634DS 612DS 634DSRE 620DWRE 634DSBE	41/2-301 (A) (836119457)	41/3-301 (836110552)	41/6-301 (B) (836119459)	41/28-302 (836646271)

(A) Monter le coussinet avec le trou et rainure du côté du bloc cylindre et celui sans trou et rainure côté opposé
Install the bearing shell with hole/groove to the cylinder block side and the one without hole and groove to the bearing cap
 (B) 2 paires par moteur / Use 2 pairs per engine

Cotes réparation disponibles sur demande / Undersized bearings available on request

COURONNE / RING GEAR

Tracteurs Tractors	Réf. / Ref.	OEM	
205-665, 600-900	41/15-25	836117970	
505-905, Séries 6000, 8000, 6000HI, 8000HI, series	41/15-26	835328783, 836117378	

Les références des pièces sont indicatives.
 Nos pièces ne sont pas d'origine

Part numbers are quoted for reference purposes only.
 Our parts and accessories are not original.



"THE RELIABLE SERVICE"



**JOINTS MOTEUR
ENGINE SEALS**

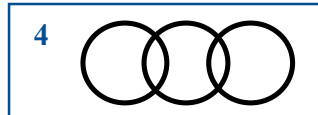

		1	2	3	4
Tracteurs <i>Tractors</i>	Moteurs <i>Engines</i>	Bague avant <i>Timing cover oil seal</i>	Bague arrière <i>Rear main oil seal</i>	Joint de chemise (sup.) <i>Liner O-ring upper</i>	Joint de chemise (inf.) <i>Liner O-ring lower</i>
205 305, 405	309D 309DS	41/11-301 (614105880)	41/13-301 (614400002)	41/38-303 (A) (836010480)	41/38-300 (B) (836038476)
505, 605 705, 805 905 8300 8600	311DS 411DS 611D 612D 612DS			41/38-304 (A) (835322233)	41/38-301 (B) (835336903)
365 465, 565, 6100 6000 6300, 6400, 6600 6400 6800 8000, 8100 8200 8400	320D 320DS 420D 420DS 420DW 420DSI 620D 634D 620DS			41/38-305 (A) (836647502)	41/38-302 (B) (836647503)

(A) 2 pièces par chemise / Use 2 pcs per liner
(B) Joint Viton / O-ring special material "Viton"

Les références des pièces sont indicatives.
Nos pièces ne sont pas d'origine



"THE RELIABLE SERVICE"



Part numbers are quoted for reference purposes only.
Our parts and accessories are not original.

JEUX DE RÉVISION MOTEUR ENGINE OVERHAUL KITS



Contient / Content :

Piston, jeu de segments et chemise / *Piston, rings & liners*
 Pochette complète / *Full gasket set*
 Coussinets de palier / *Conrod bearings*
 Coussinets de bielle / *Main bearings*
 Épaisseurs latérales / *Thrust washers*

Tracteurs <i>Tractors</i>	Moteurs <i>Engines</i>	Jeux de révision moteur <i>Engine overhaul kit</i>
33, 359, 361, 500, 502, 504, 565	311DS	41/30-200 (A) (836039027)
205 305, 405	309D 309DS	41/30-300 (836540084)
505, 605	311DS	41/30-301 (836440085)
365 465, 565, 700	320D, DS 320DS	41/30-302 (836640358)
600	320D	41/30-303 (836740334)
702, 703	411C	41/30-202 (836139423)
705, 805	411DS	41/30-201 (836140036)
665, 865 800 900	420DS 420DR 420DRS	41/30-303 (836740334)
905	611D	41/30-304 (836340268)
6000	420D	41/30-305 (836740287)
6100, 8400	320DS	41/30-306 (836640292)
6300, 6400 6200, 6250HI, 6350HI	420DS 420DSRE	41/30-305 (836740287)
6400 6600 6800 6550HI, 6650HI 6850HI	420DW 420DS 420DSF 420DWRE 420DWRIE	41/30-307 (836740288)
8000, 8100 8050, 8150 8450 8450HI	620D 620DS 620DW 620DWRE	41/30-308 (836840241)
8050HI, 8150HI	620DSRE	41/30-310 (836862101)
8200 8550, 8750 8550HI 8950HI	634D 634DS 634DSRE 634DSBE	41/30-309 (836840795)

(A) Épaisseurs latérales non incluses / *Not included thrust washers*

Les références des pièces sont indicatives.
 Nos pièces ne sont pas d'origine

*Part numbers are quoted for reference purposes only.
 Our parts and accessories are not original.*



PISTONS, JEUX DE SEGMENTS ET CHEMISES
PISTONS, RING SETS AND LINERS

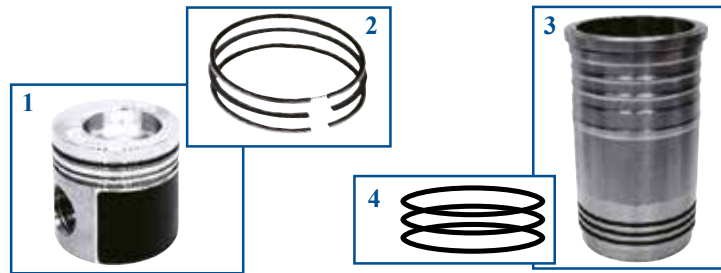

Tracteurs <i>Tractors</i>	Moteurs <i>Engines</i>	1 Piston <i>Piston</i>	2 Jeu de segments <i>Ring set</i>	3 Chemise <i>Liner</i>	4 Joint de chemise <i>Liner seal</i>
205 305, 405	309D 309DS	41/32-300 (B) (836531922)	41/34-300 (836539010)	41/35-300 (836536827)	41/37-301 (2x 836647502 + 1x 836647503)
505, 605	311DS	41/33-301 (836330700)	41/34-301 (836339201)	41/35-301 (A) (835322787)	
365 465, 565, 700	320D, DS 320DS	41/33-304 (836640073, 836640074)	41/34-303 (836640078)	41/35-302 (836647420)	
600	320D	41/33-303 (836655269)	41/34-302 (836640126, 836110233)		
705, 805	411DS	41/33-301 (836330700)	41/34-301 (836339201)	41/35-301 (A) (835322787)	
665, 865 800 900	420DS 420DR 420DRS	41/33-303 (836655269)	41/34-302 (836640126, 836110233)	41/35-302 (836647420)	
905	611D	41/33-302 (835316177)	41/34-301 (836339201)	41/35-301 (A) (835322787)	
6000	420D	41/33-303 (836655269)	41/34-302 (836640126, 836110233)	41/35-302 (836647420)	
6100	320DS	41/33-304 (836640073, 836640074)	41/34-303 (836640078)		
6300, 6400 6250HI, 6350HI	420DS 420DSRE				
6200 6400	420DSRE 420DW	41/33-303 (836655269)	41/34-302 (836640126, 836110233)		
6400, 6600 6800 6550HI, 6650HI 6850HI	420DS 420DSF 420DWRE 420DWRIE	41/33-304 (836640073, 836640074)	41/34-303 (836640078)		
8000, 8100 8050, 8150 8400 8450 8450HI	620D 620DS 320DS 620DW 620DWRE	41/33-303 (836655269)	41/34-302 (836640126, 836110233)		
8050HI, 8150HI	620DSRE	41/32-310 (B) (836659702)	41/34-302 (836640126, 836110233)		
8200 8550, 8750 8550HI 8950HI	634D 634DS 634DSRE 634DSBE	41/32-309 (B) (836840596)	41/34-303 (836640078)		
8300 8600	612D 612DS		41/34-301 (836339201)		

(A) Chemise humide / *Wet liner*
(B) Jeux de segments inclus / *Includes piston rings*

Les références des pièces sont indicatives.
Nos pièces ne sont pas d'origine









Part numbers are quoted for reference purposes only.
Our parts and accessories are not original.

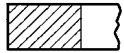

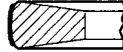
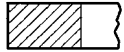
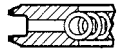
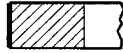
"THE RELIABLE SERVICE"



JEUX DE SEGMENTS RING SETS

Réf. Ref.	OEM									
41/34-302	836640126, 836110233	P1		2.50	P1		2.50	CBEH		4.00
41/34-303	836640078	CK1		3.00	P1		2.50	CBEH		4.00
41/34-300	836539010	CP1		2.50	P1		3.00	CBEH		4.00
41/34-301	836339201	CP1		2.50	P1		3.00	CBEH		5.00

CBEH : Chromé chanfreiné avec ressort hélicoïdal / *Chrome plated bevelled edge with helical coil spring*

CP1 : Rectangulaire chromé / *Chrome plated parallel faced*

CK1 : Trapézoïdal bilatéral chromé / *Chrome plated keystone*

P1 : Rectangulaire / *Parallel faced plain*

PISTONS PISTONS

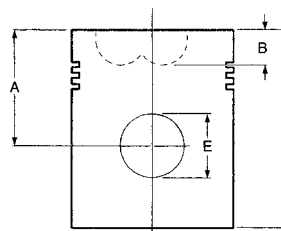
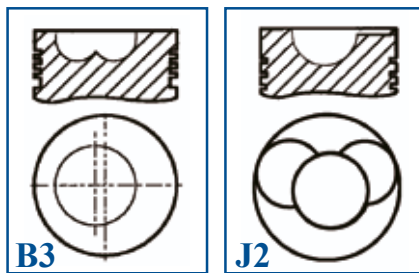

A : Hauteur de compression (mm)
Compression height (mm)

B : Profondeur de la chambre de combustion (mm)
Combustion bowl depth (mm)

D : Hauteur totale (mm)
Overall length (mm)

E : Diamètre de l'axe de piston (mm)
Gudgeon pin diameter (mm)

Réf. Ref.	Type	Alésage Bore Ø	Segm. Rings	Al-fin Al-fin	A (mm)	B (mm)	D (mm)	E (mm)
41/32-300	B3	99.50	3	n	68.90	18.75	123.70	36.00
41/33-301	B3	107.84	3	n	71.15	20.30	122.62	40.00
41/33-302	B3	107.84	3	n	70.80	22.90	122.67	40.00
41/33-303	J2	107.34	3	n	70.70	19.10	106.70	40.00

Réf. Ref.	Type	Alésage Bore Ø	Segm. Rings	Al-fin Al-fin	A (mm)	B (mm)	D (mm)	E (mm)
41/33-304	J2	107.90	3	y	70.48	18.72	106.68	40.00
41/32-309	J2	107.62	3	y	68.62	17.68	115.72	40.00
41/32-310	J2	107.40	3	n	70.51	17.96	106.70	39.90

CHEMISES LINERS

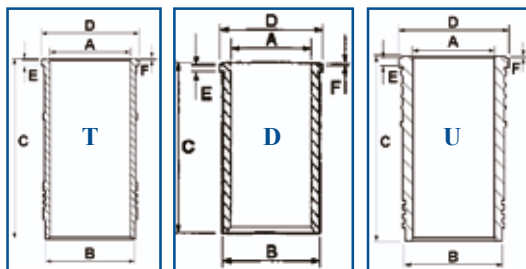

Chemises finies / Fully-finished liners

Réf. Ref.	Type	A (mm)	B (mm)	C (mm)	D (mm)	E (mm)	F (mm)
41/35-300	T	99.93	108.00	225.90	121.90	8.04	0.90
41/35-301	D	107.80	117.25	229.00	131.65	10.13	1.51
41/35-302	U	107.80	117.08	218.00	131.72	9.06	0.98

A : Alésage (mm) / *Nominal bore diameter (mm)*

B : Diamètre extérieur (mm) / *Outside diameter (mm)*

C : Hauteur totale (mm) / *Overall length (mm)*

D : Diamètre colerette (mm) / *Flange diameter (mm)*

E : Hauteur des ailettes ou colerette (mm) / *Fin height (mm)*

Les références des pièces sont indicatives.
Nos pièces ne sont pas d'origine

Part numbers are quoted for reference purposes only.
Our parts and accessories are not original.



SOUPAPES ET PIÈCES CONNEXES
VALVES AND RELATED PARTS

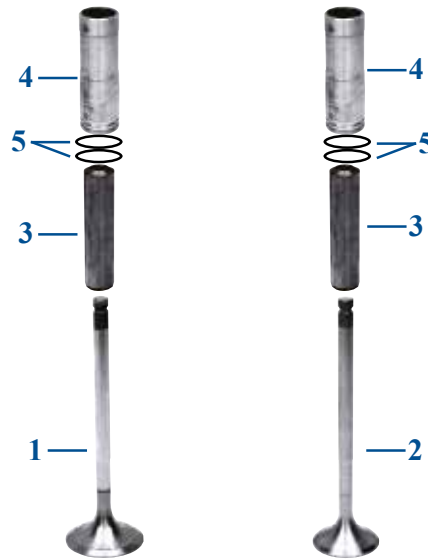

		1	2	3	4	5
Tracteurs Tractors	Moteurs Engines	Soupape adm. Inlet valve	Soupape échap. Exhaust valve	Guide de soupape Valve guide	Poussoir Tappet	O-ring O-ring
205 305, 405	309D 309DS	41/42-300 (836529951)	41/43-300 (836529950)	41/41-300 (836136051)	41/54-300 (836022081)	41/47-300 (A) (614602415)
505, 605 700MKII, 705, 805, 900 905	311DS 411DS 611D	41/42-301 (836110153)	41/43-303 (836117564, 836328734)			
365, 600 365, 465, 565, 700, 6100 665, 865, 6300, 6400 6000 6400 6600 6800 8000, 8100 8050, 8150, 8400 8200	320D 320DS 420DS 420D 420DW 420DS 420DSI 620D 620DS 634D	41/42-302 (836646356)	41/43-302 (836646357)	41/41-301 (836647601)		
8300 8600	612D 612DS	41/42-303 (836328735)	41/43-303 (836117564, 836328734)	41/41-300 (836136051)	41/54-300 (836022081)	41/47-300 (A) (614602415)

(A) 2 O-rings par manchon / O-ring needed 2 pcs per sleeve

Admission / Inlet				
Réf. Ref.	ØA (mm)	ØB (mm)	L (mm)	D (mm)
41/42-300	38.9	9.5	148.02	35°
41/42-301	44.7	8.2	148.5	45°
41/42-302	47.9	8.9	151.66	35°
41/42-303	44.7	8.2	148.5	45°

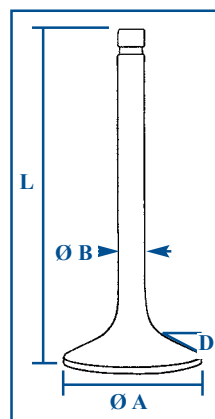

Échappement / Outlet				
Réf. Ref.	ØA (mm)	ØB (mm)	L (mm)	D (mm)
41/43-300	38.9	9.48	148.1	35°
41/43-302	39.8	9.4	148.0	35°
41/43-303	40.9	8.9	152.6	45°

Les références des pièces sont indicatives.
Nos pièces ne sont pas d'origine

Part numbers are quoted for reference purposes only.
Our parts and accessories are not original.



SOUPAPES ET PIÈCES CONNEXES
VALVES AND RELATED PARTS

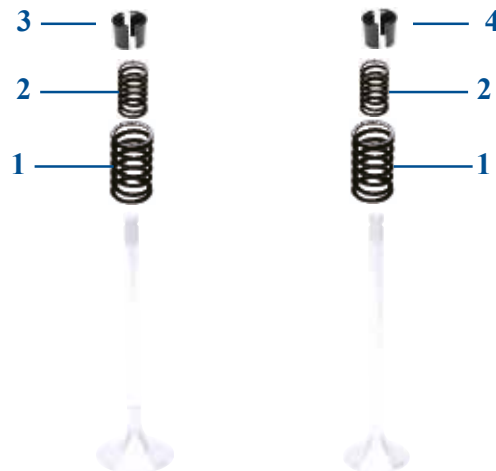

		1	2	3	4
Tracteurs <i>Tractors</i>	Moteurs <i>Engines</i>	Ressort ext. <i>Outer spring</i>	Ressort int. <i>Inner spring</i>	Clavettes adm. <i>Inlet cotter</i>	Clavettes échap. <i>Exhaust cotter</i>
205, 305, 405	309D	41/45-300 (836117910)	41/44-301 (836006574)		
505, 605 700MKII, 705, 805, 900 905	311DS 411DS 611D	41/45-300 (836117910)	41/44-301 (836006574)	41/46-300 (83649465)	41/46-301 (836117423)
365 365, 465, 565, 600, 665, 700 800, 865, 865S, 900 6000, 6100, 6200, 6300 6600 6800 6250HI, 6350HI 6550HI, 6650HI 6850HI	320D 320DS 420DRS 420DS, DW 420DS 420DSI 420DSRE 420DWRE 420DWRIE	41/45-302 (836646380)			41/46-303 (836647600)
8000, 8100 8050, 8150 8400 8450 8550, 8750 8050HI, 8150HI 8350HI, 8550HI 8450HI 8950HI	620D 620DS 320DS 620DW 634DS 620DSRE 634DSRE 620DWRE 634DSBE	41/45-302 (836646380)		41/46-302 (836647936)	41/46-303 (836647600)

Les références des pièces sont indicatives.
Nos pièces ne sont pas d'origine

Part numbers are quoted for reference purposes only.
Our parts and accessories are not original.



JOINTS MOTEUR ENGINE GASKETS

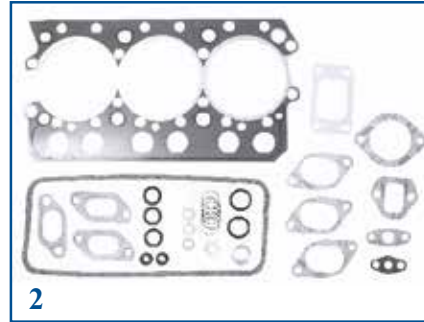
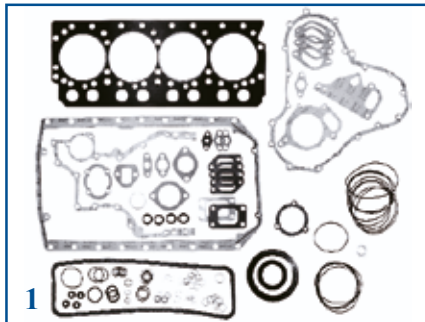

		1	2	3	4	5
Tracteurs Tractors	Moteurs Engines	Pochette complète Complete gasket set	Pochette rodage Top gasket set	Joint de culasse Cylinder head gasket	Joint cache-soupapes Rocker cover gasket	Joint de carter Sump gasket
205 305, 405	309D 309DS	41/70-315 (836589066)	41/71-300 (836539065)	41/73-300 (836536630)	41/74-300 (836322898)	41/75-300 (836006704)
365, 600, 700 365, 465, 565	320D 320DS	41/70-304 (836640356)	41/71-304 (836640289)	41/73-304 (836655395)	41/74-303 (836646360)	
505, 605	311DS	41/70-320 (836431973)	41/71-301 (836431368)	41/73-301 (836122443)	41/74-300 (836322898)	41/75-301 (836429729)
705, 805, 865, 865S	411DS	41/70-302 (836131371)	41/71-302 (836131370)	41/73-302 (836128125)	41/74-301 (836128134)	41/75-302 (836129728)
800 900	420DR 420DRS	41/70-317 (836740333)	41/71-303 (836740280)	41/73-303 (836746354)	41/74-302 (836746362)	41/75-304 (836107726)
905	611D	41/70-318 (836331748)	41/71-318 (836331747)	41/73-301 (x2) (836122443)	41/74-300 (x2) (836322898)	41/75-303 (836322183)
665, 6300, 6400 6000 6400 6600 6800 6200, 6250HI, 6350HI 6550HI, 6650HI 6850HI	420DS 420D 420DW 420DS 420DSI 420DSRE 420DWRE 420DWRIE	41/70-303 (836740281)	41/71-303 (836740280)	41/73-303 (836746354)	41/74-302 (836746362)	41/75-302 (836129728)
6100	320DS					
8000, 8100 8050, 8150, 8400 8200 8450 8550, 8750 8050HI, 8150HI 8350HI, 8550HI 8450HI 8950HI	620D 620DS 634D 620DW 634DS 620DSRE 634DSRE 620DWRE 634DSBE	41/70-319 (836840238)	41/71-319 (836840237)	41/73-304 (x2) (836655395)	41/74-303 (x2) (836646360)	41/75-303 (836322183)
8300 8300T, 8600	612D 612DS					

Les références des pièces sont indicatives.
Nos pièces ne sont pas d'origine

Part numbers are quoted for reference purposes only.
Our parts and accessories are not original.



"THE RELIABLE SERVICE"





NEZ D'INJECTEUR INJECTOR NOZZLE



Tracteurs <i>Tractors</i>	Moteurs <i>Engines</i>	Réf. <i>Ref.</i>	N° du nez <i>Nozzle N°</i>	OEM
205 305, 405 505, 605 705, 805 905	309D 309DS 311DS 411DS 611D	41/117-300 5 trous / 5 holes	DLLA150S1029, 770671	836339985, 836339087
205 305, 405 505, 605 705, 805	309D 309DS 311DS 411DS	41/117-304 4 trous / 4 holes	DLLA150S804, 433271856	835331101
365, 465, 565 665	320DS 420DS	41/117-301	DLLA150S620, 770620	836639957
565, 700 900	320DS 411DS	41/117-303	BDLL150S6429, 5621260	836010936
800 6900	420DR 620DRE	41/117-305	33426, 33426	836854757
865 900 8550	420DS 420DSR 634DS	41/117-300	DLLA150S1029, 770671	836339985, 836339087
6000 6100 6200 6300, 6600 6400 6800 8000, 8100 8200 8400 8050, 8150 8450 8750	420D 320DS 420DSRE 420DS 420DW 420DSI 620D 634D 320DS 620DS 620DW 634DS	41/117-301	DLLA150S620, 770620	836639957
6250HI 6550HI 8050, 8450	420DSRE 420DWRE 620DSR	41/117-306	ADB145M34447, 34447	836854832

JOINTS / WASHERS

Description	Réf. / Ref.	OEM
Injecteur / <i>Injector</i>	41/119-5	899901495
Tuyau de retour (2 pièces par montage) <i>Leakage pipe</i> (2 pcs needed)	41/119-6	615570812



BOUGIES DE PRÉCHAUFFAGE HEATER PLUG

Tracteurs <i>Tractors</i>	Réf. <i>Ref.</i>	Remarque <i>Observation</i>
205, 505, 604, 700, 705, 805, 900, 905, 6000, 6100, 6300, 6400, 6800, 8000, 8100, 8200, 8400	41/60-300 7/8 UNF - 14	Fixation par vis / <i>With screw terminal</i>
	41/60-301 7/8 UNF - 14	Fixation par fiche / <i>With flat terminal</i>



Les références des pièces sont indicatives.
Nos pièces ne sont pas d'origine

Part numbers are quoted for reference purposes only.
Our parts and accessories are not original.



POMPES D'ALIMENTATION
FUEL PUMPS



Tracteurs <i>Tractors</i>	Moteurs <i>Engines</i>	Fig.	Réf. <i>Ref.</i>	OEM	Remarque <i>Observation</i>
205 305, 405 365 365, 465, 565	309D 309DS 320D 320DS	1	41/100-300	836539872	Levier de contrôle avec axe <i>Control lever with pin</i>
305, 405	309DS	2	41/100-301 (A)	836439059	Levier de contrôle avec rouleau <i>Control lever with roll</i>
505, 605	311DS	2	41/100-301	836431349, 836439059	
505, 605	311DS	1	41/100-300	836539872	Levier de contrôle avec axe <i>Control lever with pin</i>
565, 700 900	320DS 411DS	3	41/100-302	836012114	
600 700, 6100	320D 320DS	1	41/100-300	836539872	
705, 805	411DS	4	41/100-303	836131348, 836139012, 835340017	
800 865 900 8050, 8150 8450 8550	420DR 420DS 420DSR 620DS 620DW 634DS	5	41/100-69	836659580, 836640932, 836659391	5 trous <i>5 holes</i>
665 905 6000 6300, 6400, 6600 6800 8000, 8100 8200 8300 8400 8600 8750	420DS 611D 420D 420DS 420DSI 620D 634D 612D 320DS 612DS 634DS	4	41/100-303	836131348, 836139012, 835340017	Levier de contrôle avec axe <i>Control lever with pin</i>

Pompes d'injection / Fuel injection pumps

800 865 900	420DR 420DS 420DSR	6	41/100-304	836754665	
tout mot. 6 cyl. / <i>All 6 cyl. eng.</i>			41/100-305	836854739	

(A) Pompe à main séparée 41/100-301A filetage M16 x 1,5mm / *Hand pump 41/100-301A (836007781), thread M16 x 1,5mm*

Les références des pièces sont indicatives.
Nos pièces ne sont pas d'origine

*Part numbers are quoted for reference purposes only.
Our parts and accessories are not original.*



"THE RELIABLE SERVICE"



**CÂBLES
CABLES**

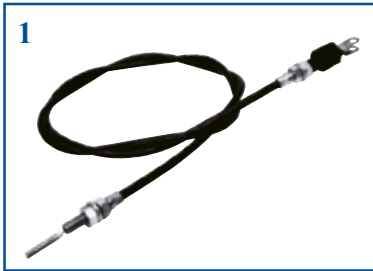

	1	2	3
Tracteurs Tractors	Câble accélérateur à pied Foot pedal cable	Câble accélérateur à main Hand throttle cable	Câble d'arrêt Stop cable
205, 305, 365, 405, 465, 600, 665, 700, 700MKII, 865, 900,			41/107-300 Lg: 2110mm (32095900, 70017100)
505, 605, 705, 805, 905		41/191-8 Lg: 2010mm (30213010)	
6000, 6100, 6300, 6400, 6600, 6800	41/191-7 Lg: 1360mm (32433810)	41/191-10 Lg: 1100mm (32438900)	
6250HI, 6350HI, 6550HI, 6650HI, 6850HI, 8050HI, 8150HI, 8350HI, 8450HI, 8550HI			
8000, 8100, 8200, 8400	41/191-9 Lg: 1490mm (32433910)		
8050, 8150, 8450, 8550, 8750			41/107-300 Lg: 2110mm (32095900, 70017100)
8300, 8300T, 8600			

Câble de compte-heures / Drive cable

700MKII, 900 (411DS)	41/177-70 (649371)	
----------------------	------------------------------	--

Les références des pièces sont indicatives.
Nos pièces ne sont pas d'origine







"THE RELIABLE SERVICE"

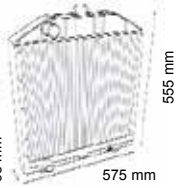

Part numbers are quoted for reference purposes only.
Our parts and accessories are not original.

RADIATEURS RADIATORS

Tracteurs Tractors	Réf. Ref.	OEM	Mesures Measurements	
305, 405 365, 465, 565 (656316⇒)	41/150-149	32611000		
505, 605 705, 805	41/150-127	30068900		

BOUCHONS DE RADIATEURS RADIATORS CAPS

Tracteurs Tractors	Moteurs Engines	Bouchon de radiateur Radiator cap	Fig.
205 305, 405 365 465, 565 505, 605 600 665, 865 700 705, 805 800 900 905 8550, 8750	309D 309DS 320D 320DS 311DS 320D 420DS 320DS 411DS 420DR 420DRS 611D 634DS	41/151-24 (30247600) Ø 60 mm	
6000 6100 6300, 6400 6400 6600 6800 8000, 8100 8200 8300 8400 8600	420D 320DS 420DS 420DW 420DS 420DSI 620D 634D 612D 620DS 612DS	41/151-25 (31679810) Ø 54 mm	

Les références des pièces sont indicatives.
Nos pièces ne sont pas d'origine

Part numbers are quoted for reference purposes only.
Our parts and accessories are not original.



DURITES DE POMPE À EAU
WATER PUMP HOSES



Tracteurs <i>Tractors</i>	Moteurs <i>Engines</i>	Fig.	Durite supérieure <i>Top hose</i>	Fig.	Durite inférieure <i>Bottom hose</i>
205 305, 405	309D 309DS	1	41/153-109 (616790)	4	41/154-111 (616800)
365 465, 565	320D 320DS				41/154-111 (616800) <i>ou/or</i> 41/154-112 (30107700) (656316⇒)
505, 605 705, 805 6000 6300 6400 6100 6600 6800	311DS 411DS 420D 420DS 420DW 320DS 420DS 420DSI	2	41/153-110 (30107800)	5	41/154-112 (30107700)
600 700 800 900 8550, 8750	320D 320DS 420DR 420DRS 634DS				41/154-112 (30107700)
905	611D	3	41/153-142 (30343500)	6	41/154-150 (30343400)
8000, 8100 8400 8200	620D 620DS 634D		41/153-142 (30343500) (665753⇒)	5	41/154-112 (30107700)

Les références des pièces sont indicatives.
Nos pièces ne sont pas d'origine



"THE RELIABLE SERVICE"





Part numbers are quoted for reference purposes only.
Our parts and accessories are not original.

**POMPES À EAU
WATER PUMPS**



Tracteurs <i>Tractors</i>	Moteurs <i>Engines</i>	Pompe à eau <i>Water pump</i>	Fig.	Kit de réparation <i>Water pump repair kit</i>
205 305, 405 365 365, 465, 565	309D 309DS 320D 320DS			41/131-121 (⇔656315) (836539064) 41/131-123 (656316⇔) (835331372)
505, 605 705, 805	311DS 411DS	41/130-123 (836136220)	2	41/131-123 (835331372)
600 700	320D 320DS	41/130-229 (836764215)	1	41/131-123 (835331372)
700MKII	411DS		5	41/131-122 (836115971)
900	411DS	41/130-122 (835339234)		
905	611D			41/131-124 (836316441)
665, 865, 865S, 6300, 6400, 6600 800 900 6000 6100 6400 6800	420DS 420DR 420DRS 420D 320DS 420DW 420DSI			41/131-123 (835331372)
6900	620DRE	41/130-230 (836864481, 836847465)	3	
6800	420DSI			41/131-160 (836115972)
6250HI, 6350HI 6550HI, 6650HI 6850HI	420DSRE 42 0DWRE 420DWRIE	41/130-229 (836764215)	1	41/131-123 (835331372)
8000, 8100 8200	620D 634D			41/131-158 (836840101)
8050, 8150, 8400 8050HI, 8150HI	620DS 620DSRE	41/130-230 (836864481, 836847465)	3	
8300 8600	612D 612DS			41/131-159 (836339723, 836340257)
8450 8450HI 8550 8550HI	620DW 620DWRE 634DS 634DSRE	41/130-231 (836864484)	4	41/131-300 (836840627)
8750 8350HI 8950HI	634DS 634DSRE 634DSBE			

	Contacteur de température Temperature switch
	41/180-13 M14 x 1,5 (98°) (654271208)

	Joint de pompe à eau Combi gasket
	41/131-301 (835339425)
	Ø int./inn. 15,80 mm Ø ext./out. 36,50 mm

Les références des pièces sont indicatives.
Nos pièces ne sont pas d'origine

Part numbers are quoted for reference purposes only.
Our parts and accessories are not original.



"THE RELIABLE SERVICE"



**COURROIES ET VENTILATEUR
FAN BELT AND FAN BLADES**

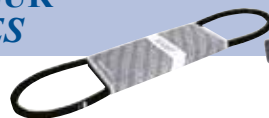
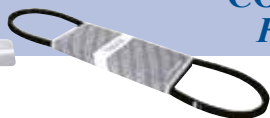

Tracteurs <i>Tractors</i>	Moteurs <i>Engines</i>	Ventilateur <i>Fan blade</i>	Courroie <i>Fan belt</i>
205 305, 405	309D 309DS		41/144-400 (684121275)
505, 605	311DS	41/145-33 (836119431)	41/144-401 (684121325)
705, 805	411DS		41/144-402 (684121300)
700MKII, 900	411DS		41/144-403
905	611D		41/144-404 (x2) (684121425)
365, 600 365, 465, 565, 700, 6100 6000 665, 6300, 6600 6400	320D 320DS 420D 420DS 420DW		41/144-401 (684121325)
800 865 900 6800	420DR 420DS 420DSR 420DSI		41/144-402 (x2) (684121300)
8000, 8100, 8200 8400	620D 620DS		41/144-405 (x2) (684121400)
8300, 8300T 8600	612D 612DS		41/144-406 (x2) (684121600)

**THERMOSTATS
THERMOSTATS**



Tracteurs <i>Tractors</i>	Thermostat <i>Thermostat</i>	Joint <i>Gasket</i>
205, 305, 405, 700MKII, 900 (411DS)	41/143-33 (79°) (836015156) 41/143-34 (82°) (836115489)	41/147-10 (836119849)
365, 465, 505, 565, 600, 605, 665, 700, 705, 800, 805, 865, 865S, 900 (420DRS), 6000, 6100, 6200, 6300, 6400, 6600, 6800, 6250HI, 6350HI, 6550HI, 6650HI, 6850HI, 8000, 8100, 8400	41/143-35 (79°) (836115646) 41/143-36 (83°) (836115718)	
905, 8000, 8100, 8400, 8050, 8150, 8300, 8450, 8550, 8600, 8750, 8050HI, 8150HI, 8350HI, 8450HI, 8550HI, 8950HI	41/143-33 (79°) (836015156) 41/143-37 (83°) (836331590)	41/147-11 (836329632)

Les références des pièces sont indicatives.
Nos pièces ne sont pas d'origine

Part numbers are quoted for reference purposes only.
Our parts and accessories are not original.



ÉCHAPPEMENTS SILENCERS

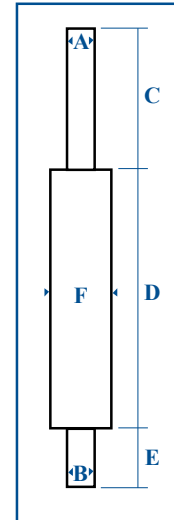

Tracteurs Tractors	Moteurs Engines	Fig.	Échappement Exhaust silencer	A	B	C	D	E	F	Description
205 305, 405 365 465, 565	309D 309DS 320D 320DS	1	41/165-118 (31009310)	61 mm	53 mm	445 mm	550 mm	200 mm	129 mm	Entre-axe Distance hole to hole 65 mm
505, 605 705, 805	311DS 411DS	2	41/165-115 (30294920)	72 mm	54 mm	330 mm	710 mm	70 mm	138 mm	Entre-axe Distance hole to hole 65 mm
465, 565	320DS	3	41/165-165 (32599200)	61 mm	44,5 mm	470 mm	530 mm	200 mm	128 mm	Entre-axe Distance hole to hole 65 mm
905	611D	4	41/165-119 (30355700)	60 mm	53 mm	555 mm	550 mm	145 mm	129 mm	Entre-axe Distance hole to hole 45 x 87 mm

Tracteurs Tractors	Moteurs Engines	Raincap Weather cap	Ø max. tuyau Pipe max Ø
205 305, 405 365 465, 565 905	309D 309DS 320D 320DS 611D	70/2930-57	57 mm 2 1/4"
505, 605 465, 565 705, 805	311DS 320DS 411DS	70/2930-76	76 mm 3"



Les références des pièces sont indicatives.
Nos pièces ne sont pas d'origine

Part numbers are quoted for reference purposes only.
Our parts and accessories are not original.



"THE RELIABLE SERVICE"



**JOINTS D'ÉCHAPPEMENT
SILENCER GASKETS**

Tracteurs <i>Tractors</i>	Moteurs <i>Engines</i>	Fig.	Joint d'échapp. <i>Silencer gasket</i>
205 305, 405 365 465, 565 505, 605 705, 805	309D 309DS 320D 320DS 311DS 411DS	1	41/167-118 (586480)
465, 565	320DS	2	41/167-117 (32589800)
905	611D	3	41/167-119 (30279900)



**JOINTS DE COLLECTEUR D'ÉCHAPPEMENT
EXHAUST MANIFOLD GASKETS**

Tracteurs <i>Tractors</i>	Moteurs <i>Engines</i>	Joint de collecteur <i>Exhaust manifold gasket</i>
205 305, 405 505, 605	309D 309DS 311DS	41/66-16 (x3) (836122886)
705, 805	411DS	41/66-16 (x4) (36122886)
905	611D	41/66-16 (x6) (36122886)



Les références des pièces sont indicatives.
Nos pièces ne sont pas d'origine

Part numbers are quoted for reference purposes only.
Our parts and accessories are not original.



**FILTRES
FILTERS**



Tracteurs Tractors	1 Air		2 Huile Oil	3 Combustible Fuel	4 Hydraulique Hydraulic	5 Transm.
	Ext. / Out.	Int. / Inn.				
205, 305, 405, 415, 415M	60/161-144 (20228654, 836128654)	60/162-144 (20228655, 836128655)	60/97-71 (836536797, 20410800)	60/111-56 (20331343)	60/641-21 (20626500, 31026500)	
255						
355, 365, 455, 465, 555, 565, 665	60/161-144 (20228654, 836128654)	60/162-144 (20228655, 836128655)	60/97-72 (20136346, 834636346)	60/111-83 (20340251, 836640251)	60/641-21 (20626500, 31026500) ⇒ F19320 60/641-24 (20639610, 31539610, 31939610) F19321 ⇒	60/240-77 (20410800, 30410800)
505, 605, 615M (311DS)	60/161-145 (20236409, 836136109, 836136409)			60/111-56 (20331343)	60/641-21 (20626500, 31026500)	60/240-78 (20406000, 30606000)
565			60/97-70 (20107806)	60/111-300 (large / rough) (20307790) 60/111-301 (fine) (20310944)		
600, 700	60/161-128 (20228300, 20228310)	60/162-128 (20228400, 20228410)	60/97-72 (20136346, 834636346)	60/111-83 (20340251, 836640251)	60/641-24 (20639610, 31539610, 31939610)	60/240-77 (20410800, 30410800)
655, 705, 755, 715, 715M	60/161-145 (20236409, 836136109, 836136409)	60/162-144 (20228655, 836128655)	60/97-73 (20136342, 836136342)	60/111-56 (20331343)	60/641-21 (20626500, 31026500)	60/240-78 (20406000, 30606000)
700	60/161-180 (20219771)		60/97-70 (20107806)	60/111-302 (20315106)	60/641-300 (20624510)	
800, 900 (1998 ⇒)	60/161-128 (20228300, 20228310)	60/162-128 (20228400, 20228410)	60/97-72 (20136346, 834636346)	60/111-4 (20339371)	60/641-24 (20639610, 31539610, 31939610)	60/240-77 (20410800, 30410800)
805, 815, 855, 905	60/161-145 (20236409, 836136109, 836136409)	60/162-144 (20228655, 836128655)	60/97-73 (20136342, 836136342)	60/111-56 (20331343)	60/641-21 (20626500, 31026500)	60/240-78 (20406000, 30606000)
865, 865S	60/161-128 (20228300, 20228310)	60/162-128 (20228400, 20228410)	60/97-72 (20136346, 834636346)	60/111-302 (20315106) 60/111-4 (20339371)	60/641-21 (20626500, 31026500) 60/641-24 (20639610, 31539610, 31939610)	60/240-77 (20410800, 30410800)

Les références des pièces sont indicatives.
Nos pièces ne sont pas d'origine

Part numbers are quoted for reference purposes only.
Our parts and accessories are not original.



"THE RELIABLE SERVICE"



**FILTRES
 FILTERS**

Tracteurs Tractors	1		2	3	4
	Air		Huile Oil	Combustible Fuel	Hydraulique Hydraulic
	Ext. / Out.	Int. / Inn.			
6000, 6300, 6400, 6600	60/161-145 (20236409, 836136109, 836136409)	60/162-144 (20228655, 836128655)	60/97-73 (20136342, 836136342)	60/111-56 (20331343)	60/641-23 (20639600, 31539600) ⇒ F16406
6300, 6400, 6600	60/161-128 (20228300, 20228310)	60/162-128 (20228400, 20228410)			
6100	60/161-145 (20236409, 836136109, 836136409)	60/162-144 (20228655, 836128655)	60/97-72 (20136346, 834636346)	60/111-4 (20339371)	60/641-24 (20639610, 31539610, 31939610) F16407 ⇒
6200	60/161-128 (20228300, 20228310)	60/162-128 (20228400, 20228410)	60/97-73 (20136342, 836136342)		
6800			60/111-56 (20331343)		
6900	60/161-148 (33038200, 20238200, 20238210)	60/162-148 (20238300, 20238310, 33028310, 33038300)	60/97-33 (20147133, 836647133)	60/111-4 (20339371)	60/641-24 (20639610, 31539610, 31939610)
8000, 8100	60/161-145 (20236409, 836136109, 836136409)	60/162-144 (20228655, 836128655)		60/111-56 (20331343)	60/111-4 (20339371)
8050, 8150, 8350	60/161-148 (33038200, 20238200, 20238210)	60/162-148 (20238300, 20238310, 33028310, 33038300)			
8200, 8400	60/161-146 (20246089, 836146089)	60/162-146 (20252235)	60/111-4 (20339371)	60/111-4 (20339371)	60/641-24 (20639610, 31539610, 31939610) F16407 ⇒
8450, 8550, 8750, 8950	60/161-148 (33038200, 20238200, 20238210)	60/162-148 (20238300, 20238310, 33028310, 33038300)			
8300, 8600 (612D, 612DS)	60/161-77 (F35807231, 807201672)	60/162-77 (F35807241)	60/97-34 (20136459)	60/625-7 (F33867011)	
8800 (620DS)			60/97-33 (20147133, 836647133)		

Les références des pièces sont indicatives.
 Nos pièces ne sont pas d'origine



"THE RELIABLE SERVICE"



Part numbers are quoted for reference purposes only.
 Our parts and accessories are not original.

Dimensions filtres
Filters sizes

Réf. Ref.	Ø x H L x l x H	Filet Thread	Réf. Ref.	Ø x H L x l x H	Filet Thread	Réf. Ref.	Ø x H L x l x H	Filet Thread
60/97-33	110 x 149	M24 x 1,5	60/111-301	85 x 73		60/162-128	85 x 375	
60/97-34	106 x 272	M30 x 1,5	60/111-302	87 x 72		60/162-144	113 x 330	
60/97-70	72 x 155	M24 x 1,5	60/111-303	80 x 130		60/162-146	114 x 450	
60/97-71	95 x 104	M24 x 1,5	60/161-77	264 x 420		60/162-148	114 x 390	
60/97-72	95 x 138	M24 x 1,5	60/161-128	165 x 380		60/240-77	95 x 104	M24 x 1,5
60/97-73	95 x 175	M24 x 1,5	60/161-144	168 x 345		60/240-78	95 x 175	M24 x 1,5
60/111-4	84 x 112		60/161-145	165 x 345		60/625-7	137 x 240	
60/111-56	76 x 123	M16 x 1,5	60/161-146	170 x 475		60/641-21	72 x 87	
60/111-83	85 x 150	M16 x 1,5	60/161-148	198 x 400		60/641-23	72 x 150	
60/111-91	70 x 130		60/161-180	178 x 328		60/641-24	72 x 180	
60/111-300	85 x 73		60/162-77	151 x 381		60/641-300	85 x 117	

Préfiltres / Pre-cleaners

Réf. Ref.	Description	Cuve Spare bowl	d1 (mm)	d2 (mm)	d3 (mm)	L1 (mm)	L2 (mm)
41/168-300	Tuyaux / Pipe 3"/ 76mm	41/169-300	90	183,5	140	77	103
41/168-301	Tuyaux / Pipe 3"/ 76mm	41/169-301	141	266	217,5	75,5	101,5
41/168-302	Tuyaux / Pipe 4"/ 101mm						

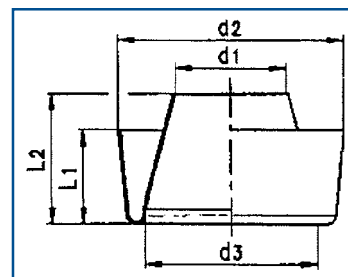

Filtres Filters	
60/111-303 (20359300)	
60/111-91 (20359302, 836859302)	

FILTRES DE CABINE
CAB FILTERS

Tracteurs Tractors	Fig.	Cabine Cab	Dimensions Sizes
205, 305, 405, 465, 565, 600, 665, 705, 805, 905 505, 605 (311DS) 800, 900 (1998 ⇌)	1	60/4200-40 (20531100)	340 x 230 x 35
6000, 6100, 6200, 6300, 6400, 6600, 6800, 6900, 8000, 8050, 8100, 8150, 8200, 8350, 8400, 8450, 8550, 8750	2	60/4200-41 (20539500)	480 x 170 x 47
	3	60/4200-42 (20531300)	470 x 178 x 48
8300, 8600, 8800	4	60/4200-25 (F33888402)	840 x 130 x 58



Les références des pièces sont indicatives.
Nos pièces ne sont pas d'origine

Part numbers are quoted for reference purposes only.
Our parts and accessories are not original.



"THE RELIABLE SERVICE"



**AVERTISSEUR SONORE
HORN**



	Klaxon Horn
	41/1995-2 (589680)
	205, 305, 405, 505, 565, 605, 700, 705, 805, 900, 905

**CENTRALES CLIGNOTANTES
BLINKING UNITS**

565, 700, 900	41/961-20 (A)	
505, 605, 705, 805, 905, 6000, 6100, 6300, 6400, 6600, 6800, 8000, 8100, 8200, 8400	41/961-21 (B) (30101100)	

**CONTACTEURS
SWITCHES**

Sonde de température / Temperature sender unit

205, 305, 365, 405, 465, 505, 565, 600, 605, 665, 700, 705, 800, 805, 865, 900 (420DSR), 905, 6000, 6100, 6200, 6300, 6400, 6600, 6800, 8000, 8050, 8100, 8150, 8300, 8400, 8450, 8550, 8600, 8750	41/180-13 M14 x 1,5 (98°) (654271208)	
700MKII, 900 (411DS)	41/180-30 M14 x 1,5 (120°) (619660, 33654271209)	
6250HI, 6350HI, 6550HI, 6650HI, 6850HI, 8050HI, 8150HI, 8350HI, 8450HI, 8550HI, 8950HI	41/180-14 M14 x 1,5 (106°) (836640772)	

Les références des pièces sont indicatives.
Nos pièces ne sont pas d'origine

Part numbers are quoted for reference purposes only.
Our parts and accessories are not original.



CONTACTEURS SWITCHES

Contacteur de pression d'huile / Oil pressure switch

205, 305, 365, 405, 465, 505, 565, 600, 605, 665, 700, 700MKII, 705, 800, 805, 865, 900, 905, 6000, 6100, 6200, 6300, 6400, 6600, 6800, 6250HI, 6350HI, 6550HI, 6650HI, 6850HI, 8000, 8050, 8100, 8150, 8300, 8400, 8450, 8550, 8600, 8750, 8050HI, 8150HI, 8350HI, 8450HI, 8550HI, 8950HI

41/186-10
(619400, 887283760)



Contacteurs de démarrage / Starting switches

700, 900, 6000, 6100, 6300, 6400, 6600, 6800, 8000, 8100, 8200, 8400

41/950-69
(816450, 32553200)



505, 605, 705, 805, 905

41/950-70
(30100800)



Contacteur combiné / Combined switch

505, 605, 705, 805, 905, 6000, 6100, 6300, 6400, 6600, 6800, 8000, 8100, 8200, 8400

41/958-70
(70057500)
Lave-glace / Essuie-glace
Wiper / wiper washer



Contacteurs / Switches

505, 605, 705, 805, 905

41/958-71
(619680)
Éclairage / Lighting
0 - Position - Croisement
0 - Parking - Traffic



505, 565, 605, 700, 705, 805, 900, 905

41/958-72
(619670)
Essuie-glace, phare de travail,
chauffage / Wiper, work lamp, heating
2 positions



505, 605, 700, 705, 805, 900, 905

41/958-73
(590780)
Lave-Glace
Wiper washer



Contacteur de relevage hydraulique / Hydraulic lift switch

Séries 6000, 8000 series

41/966-2
(32276400)



Les références des pièces sont indicatives.
Nos pièces ne sont pas d'origine

Part numbers are quoted for reference purposes only.
Our parts and accessories are not original.













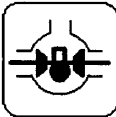



"THE RELIABLE SERVICE"



**CONTACTEURS
SWITCHES**



















Réf. Ref.	OEM	Description	Remarques Observations	
41/967-89	31877500+ 32887500	Pont avant <i>Front axle</i>	2 positions / <i>positions</i>	 
41/967-90	30943900+ 32887400	Différentiel <i>Differential</i>	3 positions, 1 retour <i>3 positions, 1 return</i>	 
41/967-91	30943900+ 32887200	Prise de force <i>PTO</i>		 
41/967-92	32733300+ 31709100	Relevage <i>Lift</i>	3 positions / <i>positions</i>	 
41/967-93	33009500+ 33009800	Relevage (descente) <i>Lift (descent)</i>	2 positions, 1 retour <i>2 positions, 1 return</i>	 
41/967-94	32276400+ 33223300	Prise de force <i>PTO</i>	3 positions, 2 retours <i>3 positions, 2 returns</i>	 
41/967-95	32276400+ 33223400	Relevage M/D <i>Lift & lower</i>		 

Les références des pièces sont indicatives.
Nos pièces ne sont pas d'origine

Part numbers are quoted for reference purposes only.
Our parts and accessories are not original.

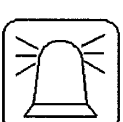

CONTACTEURS SWITCHES

Réf. Ref.	OEM	Description	Remarques Observations	
41/967-96	30943900+ 30944800	Essuie glace arrière <i>Rear wiper</i>	3 positions, 1 retour <i>3 positions, 1 return</i>	 
41/967-97	30944000+ 30944900	Ventilation cabine haute <i>Upper cab. ventilation</i>	3 positions / <i>positions</i>	 
41/967-98	30944200+ 32862400	Phare route cabine haute <i>Upper cab. lamp</i>		 
41/967-99	30944100+ 30945000	Feux de position <i>Side lights</i>	3 positions / <i>positions</i>	 
41/967-100	31781000+ 31709010	Feu de détresse <i>Hazard</i>		 
41/967-101	30944200+ 30945100	Phare de travail AV. <i>Front work lamp</i>		 
41/967-102	30944200+ 32297200	Phare de travail arrière <i>Rear work lamp</i>	2 positions / <i>positions</i>	 
41/967-103	30944200	Gyrophare <i>Beacon</i>		 

Les références des pièces sont indicatives.
Nos pièces ne sont pas d'origine

Part numbers are quoted for reference purposes only.
Our parts and accessories are not original.





"THE RELIABLE SERVICE"





ÉCLAIRAGE LIGHTING

Optiques de phare / Front light lens

Réf. Ref.	OEM	Description	Fig.	Tracteurs Tractors
41/181-100 63/1955-410	619953	Avec boîtier métallique <i>With metallic housing</i> Ampoule / Bulb 12V, 45-50W		565, 700MKII , 900
41/181-101 63/1955-410	30260801, 328704	Ampoule / Bulb 12V, 45-50W		205, 305, 365, 405, 465, 505, 565, 605, 705, 805, 905, 6000, 6100, 6300, 6400, 6600, 6800, 6250HI, 6350HI, 6550HI, 6650HI, 6850HI, 8000, 8050, 8100, 8150, 8400, 8450, 8550, 8750, 8050HI, 8150HI, 8350HI, 8450HI, 8550HI, 8950HI

Feux de position et clignotants / Front side lights and indicators

Réf. Ref.	OEM	Description	Fig.	Tracteurs Tractors
41/1918-133 41/1919-133 63/1955-245 63/1955-382	674230 714580	Cabochon / Glass Ampoule / Bulb 12V-10W Ampoule / Bulb 12V-21W		205, 305, 365, 405, 505, 605, 705, 805, 905
41/1918-134 41/1919-134 63/1955-245 63/1955-382	31540700 32082500	Cabochon / Glass Ampoule / Bulb 12V-10W Ampoule / Bulb 12V-21W		465, 565, 665, 865, 6000, 6100, 6300, 6400, 6600, 6800, 6250HI, 6350HI, 6550HI, 6650HI, 6850HI, 8000, 8050, 8100, 8150, 8400, 8450, 8550, 8750, 8050HI, 8150HI, 8350HI, 8450HI, 8550HI, 8950HI



Les références des pièces sont indicatives.
Nos pièces ne sont pas d'origine

Part numbers are quoted for reference purposes only.
Our parts and accessories are not original.

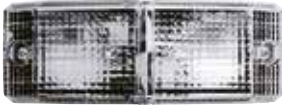

ÉCLAIRAGE LIGHTING

Feux arrière / Rear lights

Réf. Ref.	OEM	Description	Fig.	Tracteurs Tractors
41/1912-91 41/1913-122 63/1955-382 63/1955-380	30100200 30272600	Cabochon / Glass Ampoule / Bulb 12V-21W Ampoule / Bulb 12V-5W		205, 305, 365, 405, 505, 605, 705, 805, 905
41/1912-92 41/1913-123 63/1955-382 63/1955-380	31540600 32082600	Cabochon / Glass Ampoule / Bulb 12V-21W Ampoule / Bulb 12V-5W		465, 565, 665, 865, 6000, 6300, 6400, 6600, 6800, 6250HI, 6350HI, 6550HI, 6650HI, 6850HI, 8000, 8050, 8100, 8150, 8400, 8450, 8550, 8750, 8050HI, 8150HI, 8350HI, 8450HI, 8550HI, 8950HI
41/1912-200 41/1913-124 63/1955-382 63/1955-380	33899641	Cabochon / Glass Ampoule / Bulb 12V-21W Ampoule / Bulb 12V-5W		8300, 8300T, 8600

PHARES DE TRAVAIL WORK LIGHT

 <p>154, 174, 184, 194, 234S, 254, 274, 1104 Arrière / Rear</p> <p>63/1931-33</p> <p>Ampoule / Bulb : 63/1955-453 (12V/55W) (1628494M1)</p>	<p>Séries 6000 et/and 8000 series</p> <p>63/1931-34 (Gauche / LH) 31636910</p> <p>63/1931-35 (Droit / RH) 31636900</p> <p>Ampoule / Bulb : 63/1955-453 (12V/55W) (1628494M1)</p>
 <p>63/1931-28</p> <p>Ampoules incluses Bulbs included : 63/1955-453 (12V/55W) x2 (1628494M1)</p>	 <p>63/1931-29</p> <p>Ampoules incluses Bulbs included : 63/1955-453 (12V/55W) x2 (1628494M1)</p>

Les références des pièces sont indicatives.
Nos pièces ne sont pas d'origine

Part numbers are quoted for reference purposes only.
Our parts and accessories are not original.



MÉCANISMES & DISQUES D'EMBRAYAGE CLUTCH ASSEMBLIES & PLATES

Tracteurs Tractors	Embrayage Clutch		Disque Plate		Butée de débrayage Release bearing
	Ø	Ref.	Ø	Ref.	
205	280 DF	41/200-902	280	41/221-903 TF 22Z 41x45 (30960900)	
305, 365 (D, DS), 405, 465, 565, 600	295/280 GU 6	41/200-903 (30754300)	280 LG	41/221-903 TF 22Z 41x45 (30960900)	41/231-902 (582990) MS 41/231-903 (582970) MT 41/230-900 20 x 52 x 15 AU
			280 LM	41/212-901 UF 18Z 22,5x25 (30960700)	
365, 665	280/280 GU 6	41/200-904 (32043110)	280 LG	41/221-904 TC LS 22Z 41x45 (32639400)	
405, 465, 565			280 LM	41/212-900 UF 18Z 22,5x25 (32043000)	
505, 605, 705, 805	310 DF	41/200-905 (30036400)	310	41/221-905 TF 22Z 41x45 (300049210, 30049200)	41/231-904 (30208100) 41/230-901 20 x 52 x 15 AU
			310	41/221-906 AA TC LT 22Z 41x45 (30049300)	
605	330 DF	41/200-900 (30342900)	330	41/221-900 TF 22Z 41x45 (32597700)	
665, 700, 800, 865, 900	295/280 GU 6	41/200-903 (30754300)	280 LG	41/221-903 TF-22Z 41x45 (30960900)	41/231-902 (582990) MS 41/231-903 (582970) MT 41/230-900 20 x 52 x 15 AU
			280 LM	41/212-901 UF-18Z 22,5x25 (30960700)	
700MKII, 900	310/310 GU 6	41/200-906 (718010, 889810, 31970510, 31970500)	310 LG	41/221-907 TF 22Z 41x45 (723554, 30049220)	
			310 LM	41/212-902 UF 10Z 23x29 (814050)	

Les références des pièces sont indicatives.
Nos pièces ne sont pas d'origine

Part numbers are quoted for reference purposes only.
Our parts and accessories are not original.



MÉCANISMES & DISQUES D'EMBRAYAGE CLUTCH ASSEMBLIES & PLATES

Tracteurs Tractors	Embrayage Clutch		Disque Plate		Butée de débrayage Release bearing
	Ø	Ref.	Ø	Ref.	
705, 755, 805, 855	330 DF	41/200-900 (30342900)	330	41/221-901 UF 22Z 41x45 (31887800)	41/231-904 (30208100)
905	330 DF	41/200-900 (30342900)	330	41/221-908 TF 22Z 41x45 (303430)	41/230-901 40 x 68 x 15 AU
6000, 6100, 6200, 6300, 6400, 6600, 6800, 6900, 8000, 8100, 8200, 8400	330 DF	41/200-900 (30342900)	330 330	41/221-900 TF 22Z 41x45 (32597700) 41/221-901 UF 22Z 41x45 (31887800)	41/231-900 (31597300) BO
8050, 8150, 8200, 8400, 8450, 8550, 8750, 8050HI, 8150HI, 8450HI, 8550HI	360 DF	41/200-901 (32831400)	350	41/221-902 TF 22Z 41x45 (32831300)	

AA En option
 AU Roulement pilote
 BO Cylindre récepteur avec butée
 DF Diaphragme, volant plat
 GU6 Commande indépendante, 6 doigts
 LG Friction d'avancement côté BV, montée
 LM Friction prise de force côté moteur, libre
 LS 5 paires de pastilles
 LT 6 paires de pastilles
 MS Petit Ø
 MT Grand Ø
 TC Cera-métallique à ressorts
 TF Organique à ressorts
 UF Organique fixe

AA *Optional*
 AU *Spigot bearing*
 BO *Slave cylinder and release bearing are one unit*
 DF *Diaphragm, flat flywheel*
 GU6 *Independent clutch, 6 levers*
 LG *Main disc, transmission side, mounted*
 LM *PTO disc, engine side, loose*
 LS *5 pairs of pads*
 LT *6 pairs of pads*
 MS *Small diameter*
 MT *Large diameter*
 TC *Spring cera-metallic*
 TF *Spring organic*
 UF *Fixed organic*

Les références des pièces sont indicatives.
 Nos pièces ne sont pas d'origine

Part numbers are quoted for reference purposes only.
 Our parts and accessories are not original.



MÉCANISMES & DISQUES D'EMBRAYAGE
CLUTCH ASSEMBLIES & PLATES

41/200-900



41/200-901



41/200-902



41/200-903



41/200-904



41/200-905



41/200-906



41/212-900



41/212-901



41/212-902



41/221-900



41/221-901



41/221-902



41/221-903



41/221-904



41/221-905



41/221-906



41/221-907



41/221-908



Les références des pièces sont indicatives.
Nos pièces ne sont pas d'origine

Part numbers are quoted for reference purposes only.
Our parts and accessories are not original.



MAÎTRE-CYLINDRES ET CYLINDRES RÉCEPTEUR D'EMBRAYAGE
CLUTCH MASTER AND SLAVE CYLINDERS



	1	2	3	4	5
Tracteurs Tractors	Maître-cylindre Master cylinder	Kit réparation Repair kit	Cylindre récepteur Clutch slave cylinder	Kit réparation Repair kit	Réservoir Tank
700MKII, 900 (411DS)	41/226-22 (1-1) (661910) Aluminium	41/227-16 (663240)	41/228-17 (666230)	41/229-17 (691210)	41/6800-2 (813140)
	41/226-23 (1-2) (661911) Acier / Cast iron	41/227-17 (336241)			
6000, 6100, 6300, 6400, 6600, 8000, 8100, 8200, 8400	41/226-15 (1-3) (33031410)	41/227-15 (31975300)			

CÂBLE D'EMBRAYAGE
CLUTCH CABLE



Tracteurs Tractors	Réf. Ref.	OEM	Dimension
Séries 6000 et / and 8000 Series	41/198-21	32501100	Lg. 2650 mm

Les références des pièces sont indicatives.
Nos pièces ne sont pas d'origine

Part numbers are quoted for reference purposes only.
Our parts and accessories are not original.





"THE RELIABLE SERVICE"



PRISE DE FORCE
PTO

Tracteurs Tractors	Arbre de prise de force PTO shaft	
205, 305, 365, 405, 465, 565, 665		41/303-103 (30324300)
505, 605, 705, 805, 905		41/303-104 (80381900, 30040000) 540RPM
	 6 cannelures / splines	41/303-105 (70003700) 1000RPM
6000, 6100, 6200, 6300, 6400, 6600, 6800, 6900, 8000, 8100, 8200, 8400, 6250HI, 6350HI, 6450HI, 6550HI, 6850HI, 8150HI, 8350HI, 8450HI, 8550HI, 8950HI		41/303-106 (31813100)

Tracteurs Tractors	Bague d'arbre de PDF PTO shaft seal	Fig.
205, 305, 365, 405, 465, 565, 600, 605, 665, 505, 700, 705, 800, 805, 865, 900	41/305-40 (KH1191) Dim: 38 x 52 x 7	
6000, 6100, 6200, 6300, 6400, 6600, 6800, 6900, 8000, 8050, 8100, 8150, 8200, 8400, 8450, 8550, 8750	41/305-41 (KH1405) Dim: 80 x 100 x 10	
6250HI, 6350HI, 6550HI, 6650HI, 6850HI, 8050HI, 8150HI, 8350HI, 8450HI, 8550HI, 8950HI	41/305-42 (KH1228) Dim: 80 x 100 x 10	

Les références des pièces sont indicatives.
Nos pièces ne sont pas d'origine

Part numbers are quoted for reference purposes only.
Our parts and accessories are not original.



TRANSMISSION
TRANSMISSION PARTS

Fig.	Tracteurs Tractors	Réf. Ref.	Remarque Observation	
Arbre de renvoi / Counter shaft				
	505, 605, 705, 805, 905	41/278-11 (30629900)		
Pignon de vitesse / Gear wheel				
	505, 605, 705, 805, 905	41/280-3 (30630000)	61 Dents / Teeth	
Pignon de changement de vitesse rapide / Quick change gear				
	505, 605, 705	41/258-30 (70031500)	27 dents, descente 27 teeth, lowering	Roulement / Bearing 41/304-30 LA9011 Joint / Gasket 41/250-30 KH1164
	505, 605, 705, 805, 905	41/258-31 (70044800)	30 dents, montée 30 teeth, lifting	
	505, 605, 705, 805, 905	41/259-30 (70044900)	27 dents, montée 27 teeth, lifting	
Arbre de changement de vitesse rapide / Quick-change shaft				
	505, 605, 705, 805, 905	41/265-30 (70043010)		
Couronnes de synchronisation / Synchronizing rings				
	205, 305, 365, 405, 465, 505, 565, 600, 605, 665, 700, 705, 800, 805, 865, 900, 905	41/6293-2 (30263910)	Ø Int. / Inner 80 mm	
	505, 605, 705, 805, 905	41/6293-3 (30221800)	Ø Int. / Inner 87,5 mm	
Disques de PDF / PTO plates				
	505, 605, 705, 805, 905	41/316-50 (30030100)	7 par tracteur 7 per tractor	Disque intermédiaire Intermediate disc
		41/317-50 (30030000)	6 par tracteur 6 per tractor	Disque de friction Friction disc

Les références des pièces sont indicatives.
Nos pièces ne sont pas d'origine

Part numbers are quoted for reference purposes only.
Our parts and accessories are not original.



**PDF INDÉPENDANTE
INDEPENDENT PTO DRIVE**



	1	2	3	4
Tracteurs Tractors	Moyeu de PTO PTO HUB	Arbre de PTO PTO Drive shaft	Roulement Bearing	Roulement pour arbre de PTO Bearing for PTO shaft
505, 605, 705, 805, 905	41/6301-1 (⇒605677) (30021810) Ø 168mm 41/6301-2 (605678⇒) (30021820) Ø 176mm	41/303-67 (⇒605677) (30014500) Lg. 2413mm 41/303-66 (605678⇒) (30014510) Lg. 2408mm	41/304-29 (LA1992)	41/304-30 (LA9011)
6000, 6100, 6300, 6400, 6600, 6800, 8000, 8100, 8200, 8400	41/6301-2 (30021820)			

Les références des pièces sont indicatives.
Nos pièces ne sont pas d'origine

Part numbers are quoted for reference purposes only.
Our parts and accessories are not original.



FREINS À DISQUE (SEC)
DRY DISC BRAKES

	1	2	3
Tracteurs Tractors	Jeu de garnitures Drum brake lining set	Jeu de disques Brake disc set	Bague Brake shaft seal
565	41/404-100		
700MKII		41/421-30 (671050) Ø 178 mm	41/429-30 (KH1065) 41/429-31 (KH1111)
900		41/421-31 (820230) Ø 203 mm	41/429-32



RÉSERVOIR DE LIQUIDE FREINS / BRAKE FLUID TANK		
Tracteurs Tractors	Réf. Ref.	OEM
700, 900	41/6800-2	813140



CYLINDRES DE FREIN
BRAKE CYLINDERS



Tracteurs Tractors	Maître cyl. Master cyl.	Jeu de rép. Repair kit	Cylindre de frein Slave cylinder	Jeu de rép. Repair kit
700, 900	1 41/226-22 (661910) Aluminium	41/227-16 (1-1) (663240) Aluminium		41/414-18 (1-2) (662362)
	2 41/226-23 (661911) Acier / Cast iron	41/227-17 (2-1) (663241) Acier / Cast iron		
505, 605, 705, 805, 905, 6000, 6100, 6200, 6300, 6400, 6600, 6800, 8000, 8050, 8100, 8150, 8200, 8400, 8450, 8550, 8750, 6250HI, 6350HI, 6550HI, 6650HI, 6850HI, 8050HI, 8150HI, 8350HI, 8450HI, 8550HI, 8950HI	3 41/410-19 (30294600) Acier / Cast iron	41/411-19 (3-1) (30418100) Acier / Cast iron	4 41/413-19 (30181500)	41/414-19 (4-2) (30418200)



Les références des pièces sont indicatives.
Nos pièces ne sont pas d'origine

Part numbers are quoted for reference purposes only.
Our parts and accessories are not original.



"THE RELIABLE SERVICE"



**FREINS À DISQUE (À BAIN D'HUILE)
OIL BATH DISC BRAKES**



	1	2	3	4	5
Tracteurs Tractors	Disque de friction Friction disc	Disque intermediaire Intermediate disc	Mécanisme Actuator assembly	Ressort Actuator spring	Bille Actuator ball
305, 405		41/423-9 (C) (411040)		41/419-5 (412810)	
505, 605, 705	41/422-19 (A) (30184800)		41/417-12 (411020)		41/418-4 (412960)
805, 905, 6000, 6100, 6300, 6400, 6600, 6800, 8000, 8100, 8200, 8400	41/422-19 (B) (30184800)	41/423-9 (D) (411040)			
6400, 6600, 6800	41/422-86 (B) (34401400)	41/423-86 (34123900)			

(A) 8 par tracteur / Per tractor - (B) 10 par tracteur / Per tractor - (C) 4 par tracteur / Per tractor - (D) 6 par tracteur / Per tractor

**CÂBLE DE FREIN À MAIN
HANDBRAKE CABLE**



Tracteurs Tractors	Réf. Ref.	OEM	Dimension
Séries 6000 et / and 8000 Series	41/409-50	9999950, 31747220	Lg. 940 mm



Les références des pièces sont indicatives.
Nos pièces ne sont pas d'origine

Part numbers are quoted for reference purposes only.
Our parts and accessories are not original.





GOUJONS ET ÉCROUS DE ROUE WHEEL BOLTS AND NUTS

Goujons et écrous de roue arrière / Rear wheel bolts and nuts

Fig.	Tracteurs Tractors	Réf. Ref.	Description	
	205, 305, 365, 405, 465, 565, 665	41/440-60 (31132410, 655835)	Goujon Bolt	M18 x 1,5mm
		41/441-60 (JB8206, F20321)	Écrou Nut	
	505, 605, 705, 805, 905	41/440-61 (671441)	Goujon Bolt	M20 x 1,5mm
		41/441-61 (30247400)	Écrou Nut	

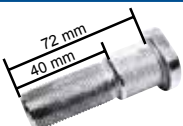
Goujons et écrous de roue / Wheel bolts and nuts

Fig.	Tracteurs Tractors	Réf. Ref.	Description
	505, 600, 605, 700, 705, 805, 800, 865, 900, 905, 6000, 6100, 6200, 6300, 6400, 6900, 6600, 6800, 8000, 8100, 8200, 8400, 8050, 8150, 8450, 8550, 8750, 6250HI, 6350HI, 6550HI, 6650HI, 6850HI, 8050HI, 8150HI, 8350HI, 8450HI, 8550HI, 8950HI	41/440-62 (31796200)	M20 x 1,5
	505, 600, 605, 700, 705, 805, 800, 865, 900, 905, 6000, 6100, 6200, 6300, 6400, 6900, 6600, 6800, 8000, 8100, 8200, 8400, 8050, 8150, 8450, 8550, 8750, 6250HI, 6350HI, 6550HI, 6650HI, 6850HI, 8050HI, 8150HI, 8350HI, 8450HI, 8550HI, 8950HI	41/441-62 (JB8205)	M20 x 1,5

PIÈCES D'AVANT-TRAIN FRONT AXLE PARTS

	1	2	3	4
Tracteurs Tractors	Jeu de réparation Repair kit	Bague Bush	Roulement inférieur Lower bearing	Roul. sup. Top bearing
565 I	41/475-100 Fusée/Spindle Ø 30 - 40	41/477-100	41/479-100 (L30208, LA5013)	
505, 605, 705, 805, 700, 900	41/475-102 Fusée/Spindle Ø 35 - 54	41/477-103 (LA9017)	41/479-101 (662220)	41/477-102 (LA9016)



Tracteurs Tractors	Kit de réparation Repair kit
565	41/460-100
700	41/460-102
900	41/460-101

Les références des pièces sont indicatives.
Nos pièces ne sont pas d'origine

Part numbers are quoted for reference purposes only.
Our parts and accessories are not original.



"THE RELIABLE SERVICE"



**PONT AVANT
FRONT AXLE**



Tracteurs Tractors	Essieu avant Front axle	1		2	3
		Bague d'arbre de transmission Drive shaft seal		Bague de moyeu Front hub seal	
		1. Ext. / Outer	2. Int. / Inner		
205, 305, 405	ZF APL 335	41/6407-70 (31372000)		41/6408-70 (31062710) (33248⇒)	
365, 465, 565, 665, 865	SIGE 658483⇒		41/6407-76 (31800500)	41/6408-74 (31795900)	
505, 605, 705, 805, 905	709/20	41/6407-71 (KH1209)	41/6407-72 (KH1213)	41/6408-71 (KH1214)	
	AE3	41/6407-73 (KH1163)	41/6407-74 (KH1161)	41/6408-72 (KH1158)	
505, 605, 705, 805, 905 VEA/302-	AE3	41/6407-75 (KH1216)		41/6408-73 (KH1215)	
505, 605, 705, 805, 905	SIGE	41/6407-76 (31800500)	41/6407-77 (31790500, 31790510)	41/6408-74 (31795900)	
600, 700, 800, 900	SIGE		41/6407-76 (31800500)	41/6408-75 (31795910)	
6000, 6100, 6200, 6300, 6400, 6600, 6800, 6900, 6250HI, 6350HI, 6550HI, 6650HI, 8000, 8100, 8200, 8400	SIGE	41/6407-76 (31800500)	41/6407-77 (31790500, 31790510)		
6600, 6800, 6900, 6650HI, 6850HI, 8050, 8100, 8200, 8400, 8450, 8550, 8750, 8050HI, 8350HI, 8450HI, 8550HI, 8950HI	SIGE IND	41/6407-78 (31800610)	41/6407-76 (31800500)	41/6408-74 (31795900)	
6650HI, 6850HI, 8050HI, 8150HI, 8350HI, 8450HI, 8550HI, 8950HI	CARRARO IND		41/6407-75 (KH1216)		

Tracteurs Tractors	Essieu avant Front axle	4		5
		Boîtier Housing		Couple conique Bevel pinion + crown wheel
		Gauche / LH	Droit / RH	
505, 605, 705, 805	Carraro 709/20	41/6400-70 (30400630)	41/6400-71 (30400730)	
	Carraro AE3			41/341-70 (3039700, 720720)

Les références des pièces sont indicatives.
Nos pièces ne sont pas d'origine

Part numbers are quoted for reference purposes only.
Our parts and accessories are not original.



"THE RELIABLE SERVICE"



CROISILLONS UNIVERSAL JOINTS

Tracteurs Tractors	Réf. Ref.	Remarque Observation	Fig.
505, 605, 705, 805, 905 Avec pont avant Carraro With Carraro front shaft	41/6403-100 (721005)	35 x 96,8 mm	

JOINTS DE VÉRIN DE DIRECTION STEERING CYLINDER GASKETS

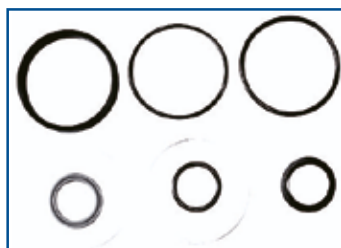

Tracteurs Tractors	Pont avant Front axle	Joins de vérin de direction Steering cylinder gaskets set
205, 305, 405	ZF	41/585-35 (31069300)
365, 465, 565, 600, 665, 700, 800, 865, 900	SIGE	41/585-31 (⇔ 129/92) (32263500) 41/585-32 (130/92⇔) (31955600)
505, 605, 705, 805, 905	709/20 AE3	41/585-33 (730680)
505, 605, 705, 805, 905, 6000, 6100, 6200, 6300, 6400, 6600, 6800, 6900, 8000, 8100, 8200, 8400	SIGE	41/585-30 Axe / Rod 32 mm (31797500) 41/585-31 Axe / Rod 40 mm (32263500)
6250HI, 6350HI, 6550HI, 6650HI, 6850HI, 8050HI, 8150HI, 8350HI, 8450HI, 8550HI, 8950HI, 8050, 8150, 8450, 8550, 8750	SIGE	41/585-34 (31797510)

Les références des pièces sont indicatives.
Nos pièces ne sont pas d'origine

Part numbers are quoted for reference purposes only.
Our parts and accessories are not original.



ROTULES ET TIRANTS DE DIRECTION 2RM
TIE ROD AND SOCKETS 2WD

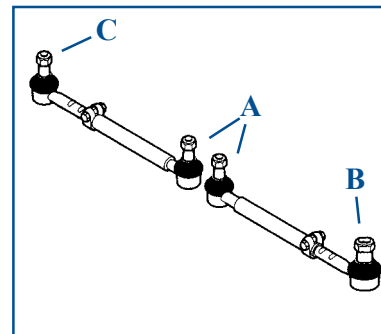
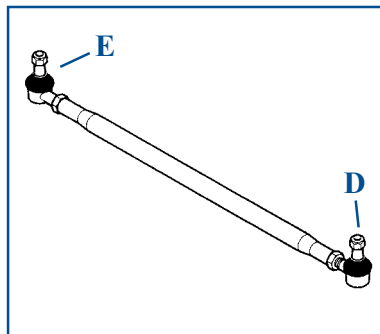
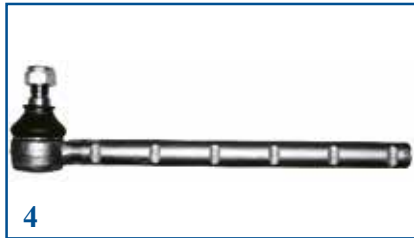
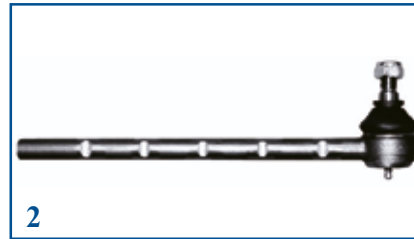

Tracteurs Tractors	Réf. Ref.	Fig.	Pos.	Filetage Thread	Longueur Length	Conicité Cone
305, 405	41/495-135 (609408)	1	B	-	310 mm	16/18
	41/495-136 (609409)	2	C	-	310 mm	
	41/497-136 (609404)	3	A	M20 x 1,5	97 mm	
900	41/495-300 (821030)	4	B, C	-	315 mm	18/20
	41/495-138 (827480)	5	A	M24 x 1,5	103 mm	
505, 605, 705, 805	41/495-137 (30002200, 698940)	6	D	-	520 mm	
	41/495-138 (827480)	5	E	M24 x 1,5	103 mm	

Les références des pièces sont indicatives.
Nos pièces ne sont pas d'origine

Part numbers are quoted for reference purposes only.
Our parts and accessories are not original.



"THE RELIABLE SERVICE"



TIRANTS ET ACCOUPLEMENTS DE DIRECTION 4 RM
STEERING COUPLINGS 4 WD

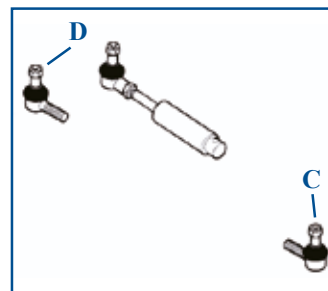
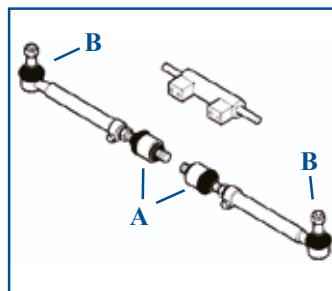

Tracteurs Tractors	Type	Fig.	Pos.	Réf. Ref.	OEM			
205, 305, 365, 405, 415, 465, 565, 665, 865	APL 325	1	A	41/497-137	31059800	22x1.5/18x1.5 RH	180	
		2	B	41/495-139	31059900	F 18x1.5 RH	236	20/22
	APL 335	1	A	41/497-137	31059800	22x1.5/18x1.5 RH	180	
		2	B	41/495-140	31372400	F 18x1.5 RH	295	20/22
205, 305, 365, 405, 465, 565, 600, 665, 700, 800, 865, 900	SIGE	1	A	41/497-138	31798520	22x1.5/22x1.5 RH	210	
		2	B	41/495-141	31952500	F 22x1.5 RH	160	23.5/26
505, 605, 705, 805, 905	CARRARO	3	D	41/495-143	30405610	M 22x1.5 RH	103	16/18
	C		41/495-144	30405210	M 22x1.5 LH			
505, 605, 705, 805, 905	CARRARO HD		D	41/495-145	720886	M 24x1.5 RH	108	20/22
	C	41/495-146	720885	M 24x1.5 LH				
505, 605, 705, 805, 905, 6200, 6300, 6400, 6600, 6800, 8000, 8050, 8100, 8150, 8400, 8450, 8550, 8750	SIGE	1	A	41/497-138	31798510, 31798520	22x1.5/22x1.5 RH	210	
		2	B	41/495-142	31798600, 31798610	F 22x1.5 RH	210	23.5/26
6000, 6100, 6200, 6300, 6400, 6600, 6800, 8000, 8050, 8100, 8150, 8400, 8450, 8550, 8750	SIGE	1	A	41/497-138	31798510, 31798520	22x1.5/22x1.5 RH	210	
		2	B	41/495-147	31882200	F 22x1.5 RH	290	23.5/26
	SIGE	1	A	41/497-138	31798520	22x1.5/22x1.5 RH	210	
		2	B	41/495-148	31882210	F 22x1.5 RH	293	29/32
8300, 8300T, 8600		1	A	41/497-139	3426255	22x1.5/24x1.5 RH	210	
		2	B	41/495-149	3426276	F 24x1.5 RH	270	23.5/26

Les références des pièces sont indicatives.
Nos pièces ne sont pas d'origine

Part numbers are quoted for reference purposes only.
Our parts and accessories are not original.



"THE RELIABLE SERVICE"



POMPES HYDRAULIQUES
HYDRAULIC PUMPS



Tracteurs Tractors	Fig.	Réf. Ref.	OEM	Débit cc. Flow cc.
205, 305, 365,405, 465, 565, 665	1	41/640-300	731310, 32905600	15 + 11
	2	41/640-301	731320, 31851700	18 + 15
305, 405	3	41/640-302	731430, 731900	23 + 15
505, 605, 705, 805, 905 (⇒ 607100)	4	41/640-303 Pont Carraro Carraro axle	30225110	22,5 + 12
505, 605, 705, 805, 905 (607100 ⇒)	4	41/640-304 Pont Sige Sige axle	30225120	22,5 + 16,8
6000, 6100, 6200,6300, 6400, 6600, 6800, 6900, 8000, 8050, 8100, 8150, 8200, 8400, 8450, 8550, 8750	5	41/640-305 (⇒658899)	31852310, 34306100	23,5 + 6
	6	41/640-37 Pont Sige Sige axle	31852330, 33564400	25 + 8
	7	41/640-307 Pont ZF ZF axle	33561800, 32863100	25 + 11

Arbre Shaft
Pour / For 41/640-300, 41/640-301, 41/640-302
41/651-1 (686300)



Les références des pièces sont indicatives.
Nos pièces ne sont pas d'origine

Part numbers are quoted for reference purposes only.
Our parts and accessories are not original.



RELEVAGE HYDRAULIQUE
HYDRAULIC LIFT

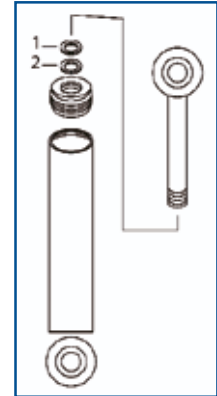
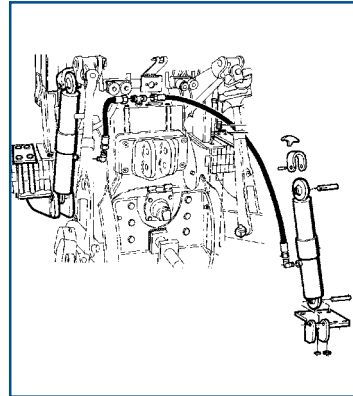
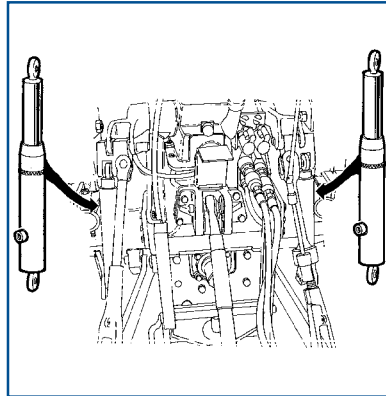
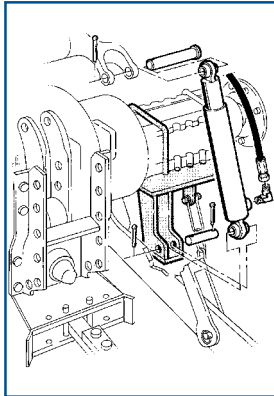

	1	2
Tracteurs Tractors	Joint ext. Outer seal	Joint int. Inner seal
505, 605, 705, 805, 905	41/692-50 (KH3305) 30 x 38 x 4 x 7 mm	41/692-53 (KH3306) 30 x 38 x 8 mm
805, 905	41/692-52 (KH3319) 40 x 48 x 4 x 7 mm	41/692-54 (KH3320) 40 x 48 x 8 mm
865, 800, 900	41/692-51 (KH3300) 22 x 30 x 7,3 mm	
6000, 6100, 6200, 6300, 6400, 6900, 8000	41/692-50 (KH3305) 30 x 38 x 4 x 7 mm	41/692-53 (KH3306) 30 x 38 x 8 mm
6600, 6800, 8100, 8200, 8400, 6250HI, 6350HI, 6550HI, 6650HI, 6850HI, 8050, 8150, 8450, 8550, 8750, 8050HI, 8150HI, 8350HI, 8450HI, 8550HI, 8950HI	41/692-52 (KH3319) 40 x 48 x 4 x 7 mm	41/692-54 (KH3320) 40 x 48 x 8 mm

	3	4
Tracteurs Tractors	Bague Supporting ring	Joint Seal
205, 305, 365, 405, 465, 565, 665, 865 (610312⇒)	41/692-55 (KH3316) 100 x 84,5 x 6,3 mm	41/692-57 (KH3317)
600, 700, 800, 900		
305, 405 (⇒610311)	41/692-56 (KH3275)	



Les références des pièces sont indicatives.
Nos pièces ne sont pas d'origine

Part numbers are quoted for reference purposes only.
Our parts and accessories are not original.





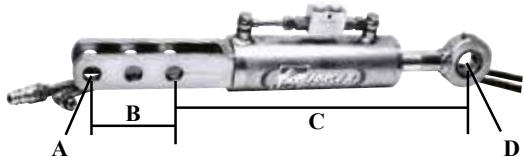
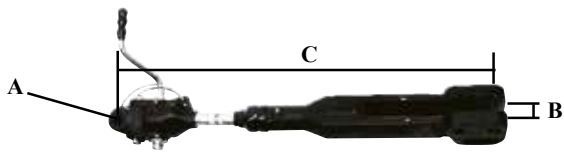

TIRANTS DE RELEVAGE LEVELLING BOXES

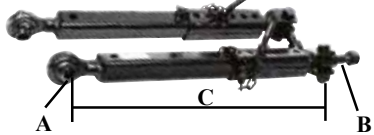
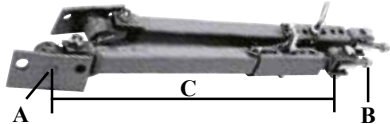
Tracteurs Tractors	Réf. Ref.	Fig.
505, 605, 705, 805	41/760-101 A: Ø 28 mm B: 36 mm C: Max. 690 mm D: Ø 40 mm bague / bush 32 ou/ or 37mm	
565	41/760-100 A: Ø 22 mm B: 21 mm C: Max. 780 mm	

STABILISATEURS STABILIZERS

Tracteurs Tractors	Réf. Ref.	Fig.
505, 605, 705, 805, 905	41/735-8 41/735-8A A: Ø 19 mm (41/735-8) A: Ø 24 mm (41/735-8A) B: Ø 19 mm C: 510 mm	
565	41/735-7 A: Ø 20 mm B: 16 mm C: 650 mm	

BARRES DE POUSSÉE TOP LINKS







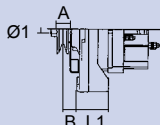
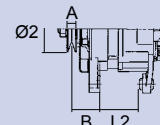

Réf. Ref.	Fig.	Lg. tube Tube length	Filet Thread	Remarque Comment
41/700-57		309 mm	M36	Séries 6000 & 8000 series
41/700-58		306 mm	M36	-
41/700-60		309 mm	M36	-
41/700-59		334 mm	M42	-
41/700-61		455 mm	M42	-

Les références des pièces sont indicatives.
Nos pièces ne sont pas d'origine

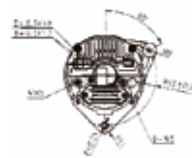

Part numbers are quoted for reference purposes only.
Our parts and accessories are not original.

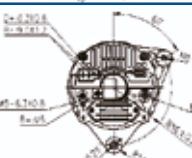

ALTERNATEURS
ALTERNATORS

Tracteurs Tractors	OEM	Réf. Ref.	Ø1  B L1	Ø2  B L2
505, 605, 705, 805, 905, 8050, 8100, 8150, 8200, 8400, 8450	835339304, 81868798	62/920-10 14V-65A	 ↻ Ø2 A B L2 85 13 37 90	
865, 6000, 6100, 6300, 6400, 6600, 6800, 8000, 8100, 8200	836640128, 836640927	62/920-71 95A	 ↻ Ø1 L1 17 56	
ME220 / MEGA		62/920-108 14V-70A	 ↻ Ø1 A B L2 17 82	
T130, T140, T150, T160		62/920-162 120A	 ↻ Ø1 A B L1 56	

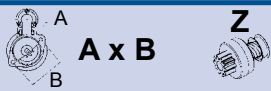
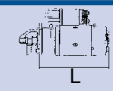
DÉMARREURS
STARTER MOTORS

Tracteurs Tractors	OEM	Réf. Ref.	 A x B Z	 L
305, 405, 505, 605, 700, 705, 805, 900, 6000	835331592	62/930-43 Iskra 12V / 3kW	3x127 	11Z 243
365, 465, 565, 665, 865, 6100, 6300, 6400, 6600, 6800, 8000, 8050, 8100, 8200, 8150, 8400, 8450, 8550, 8750	836640940	62/930-44 Iskra 12V / 3kW	3x127 	10Z 243

Les références des pièces sont indicatives.
Nos pièces ne sont pas d'origine

Part numbers are quoted for reference purposes only.
Our parts and accessories are not original.



"THE RELIABLE SERVICE"



PEINTURE PAINT

LAQUE AMERICAINE

LA MEILLEURE PEINTURE
DU MARCHE



*THE BEST PAINT
ON THE MARKET*



Plus de 2000 nuances possibles
Possibilité de créer une couleur
suivant échantillon

*More than 2000 colors available
Possibility to create a color
from a sample*

Teinte Colour	1L	5L	Spray
Vert métallique <i>Metalic green</i>	41/3102-300	41/3102-301	41/3102-302
Bleu métallique <i>Metalic blue</i>	41/3102-303	41/3102-304	41/3102-305
Vert chardon métallique <i>Thistle metalic green</i>	41/3102-306	41/3102-307	41/3102-308
Noir <i>Black</i>	41/3102-309	41/3102-310	41/3102-311
Rouge <i>Red</i>	41/3102-312	41/3102-313	41/3102-314
Bleu <i>Blue</i>	41/3102-315	41/3102-316	41/3102-317
Vert <i>Green</i>	41/3102-318	41/3102-319	41/3102-320

SIÈGES SEATS

61/830-971 : Tissu noir / *Black cloth*

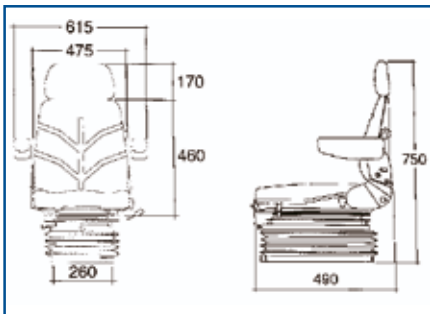

- Appuie-tête et accoudoirs réglables
Backrest extension and armrests
- Suspension et hauteur réglables avec limiteur de course automatique suivant le poids du conducteur
Adjustable suspension & height
- Suspension horizontale munie d'un blocage
Horizontal suspension with dead lock
- Dossier muni d'un réglage lombaire
Adjustable lumbar support
- Glissières (150mm)
Slide rails adjustment (150 mm)
- Dossier inclinable
Backrest tilt adj.
- Base plane
Flat mounting plate

61/830-984

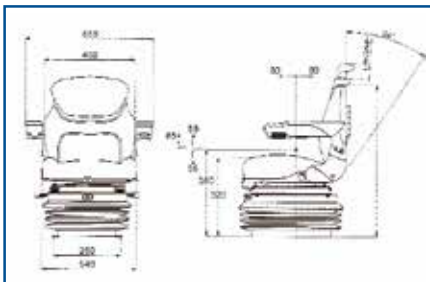

- Sellerie tissu "Safari"
"Safari" cloth
- Appuie-tête et accoudoirs réglables
Backrest extension and armrests
- Hauteur réglable (60mm)
Height adjustment (60mm)
- Réglage poids (>130kg)
Weight adjustment (>130kg)
- Glissières à 2 blocages (160mm)
Slide rails adjustment (160mm)
- Dossier inclinable 34° / repliable
Fully foldable backrest with 34° tilt adj.
- Réglage lombaire
Mechanical lumbar adjustment
- Base plane
Flat mounting plate
- Fixations pour ceinture de sécurité
Seat belt fixation points

- Options :
- Embase pivotante 12°/20°/45° *Turn table - 61/835-6*
 - Embase pivotante 0°/180° *Turn table - 61/835-7*
 - Ceinture de sécurité / *Refrectable seat belt - 61/833-2*

Pour d'autres sièges voir notre fascicule 1 / *For another seat please see our catalogue 1*

Les références des pièces sont indicatives.
Nos pièces ne sont pas d'origine







"THE RELIABLE SERVICE"



Part numbers are quoted for reference purposes only.
Our parts and accessories are not original.

CHAUFFAGES DE CABINE
CAB HEATERS

Tracteurs <i>Tractors</i>	Réf. <i>Ref.</i>	OEM	Remarques <i>Remarks</i>	Fig.
205, 305, 405, 505, 605, 705, 805, 905	41/1988-50	T50010	Gauche / <i>LH.</i>	
505, 605, 705, 805, 905	41/1988-51	T50009	Droit / <i>RH.</i>	
6000, 6100, 6200, 6300, 6400, 6600, 6800, 8000, 8050, 8100, 8150, 8300, 8400, 8450, 8550, 8750 (⇒656099)	41/1988-52	31691800		
6000, 6100, 6200, 6300, 6400, 6600, 6800, 6900, 8000, 8050, 8100, 8150, 8200, 8300, 8400, 8450, 8550, 8750, 6250HI, 6350HI, 6450HI, 6550HI, 6850HI, 8150HI, 8350HI, 8450HI, 8550HI, 8950HI (656100⇒)	41/1988-53	33508700		
6000, 6100, 6200, 6300, 6400, 6600, 6800, 6900, 8000, 8050, 8100, 8150, 8200, 8400, 8450, 8550, 8750, 6250HI, 6350HI, 6450HI, 6550HI, 6850HI, 8150HI, 8350HI, 8450HI, 8550HI, 8950HI (656100⇒)	41/1988-55	32729820, 32729810	Unité complète <i>Blower unit complete</i>	
6000, 6100, 6200, 6300, 6400, 6600, 6800, 6900, 8000, 8100, 8200, 8400, 6250HI, 6350HI, 6450HI, 6550HI, 6850HI, 8150HI, 8350HI, 8450HI, 8550HI, 8950HI	41/1988-54	32519000	Chauffage de sol <i>To floor heater</i>	

AIR CONDITIONNÉ
AIR CONDITIONING

Séries 6000 et/and 8000 series

Réf. <i>Ref.</i>	Fig.	Description
82/9202-168	1	Compresseur / <i>Compressor</i>
82/9202-457	2	Filtre / <i>Filter</i>



Les références des pièces sont indicatives.
Nos pièces ne sont pas d'origine

Part numbers are quoted for reference purposes only.
Our parts and accessories are not original.



BALAIS D'ESSUIE-GLACE WIPER BLADES

Tracteurs Tractors	Réf. Ref.	OEM	Longueur Length
205, 305, 405, 505, 605, 705, 805, 905, 8100, 8300, 8600	70/1987-18	30302108	450 mm



RÉTROVISEURS MIRRORS



Tracteurs Tractors	Fig.	Réf. Ref.	OEM	Description	Remarque Observation
205, 35, 405, 505, 605, 705, 805, 905, 6000, 6100, 6200, 6300, 6400, 6600, 6800, 6900, 6250HI, 6350HI, 6550HI, 6650HI, 6850HI, 8000, 8050, 8100, 8150, 8200, 8300, 8300T, 8400, 8450, 8550, 8600, 8750, 8050HI, 8150HI, 8350HI, 8450HI, 8550HI, 8950HI	1	41/850-5	30581200, 30127200	Rétroviseur / <i>Mirror</i>	180 x 320 mm Convex Ø 16-22 mm Extérieur / <i>Ext.</i>
		41/851-10	30581300	Glace / <i>Glass</i>	
	2	41/850-6	32875400, 30114100	Rétroviseur / <i>Mirror</i>	160 x 254 mm Convex Ø 22 mm Intérieur / <i>Int.</i>
		41/851-11		Glace / <i>Glass</i>	
	3	41/850-7	32738800, 30127200	Rétroviseur / <i>Mirror</i>	135 x 185 mm Convex Ø 13-16 mm
		41/851-12	32711900	Glace / <i>Glass</i>	

VÉRINS À GAZ GAS STRUTS



Tracteurs Tractors	Vitre arrière Rear window	Toit Roof	Porte Door
205, 305, 405	41/870-99 (30314200)		
365, 465, 565, 665			41/872-66 (31517900)
505, 605, 705, 805, 905	41/870-96 (30077200)		41/872-65 (30191700)
865, 600, 700, 800, 900	41/870-104 (32995000)		
6000, 6100, 63006400, 6600, 6800, 8000, 8050, 8100,8150, 8200, 8400, 8450, 8550, 8750, 6250HI, 6350HI, 6550HI, 6650HI, 6850HI, 8050HI, 8150HI, 8350HI, 8450HI, 8550HI, 8950HI	41/870-97 (31631300)	41/871-40 (32241400)	41/872-66 (31517900)
8300, 8600, 8800	41/870-98 (F33895561)	41/871-41 (F33030211)	41/872-67 (F33853161)

Les références des pièces sont indicatives.
Nos pièces ne sont pas d'origine

Part numbers are quoted for reference purposes only.
Our parts and accessories are not original.



"THE RELIABLE SERVICE"



VITRERIE DE CABINE
CAB GLASS

205, 305, 405

Vitres teintées / *Tinted glass*

Pare-brise / *Windscreen*

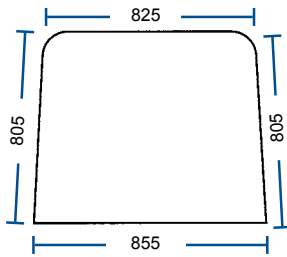

41/4000-69
(30752800)

Avant inférieure / *Lower front*

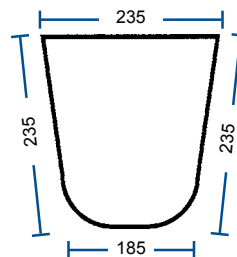

41/4012-48
(30752900)

Gauche / *LH*
Droit / *RH*



Porte / *Door*

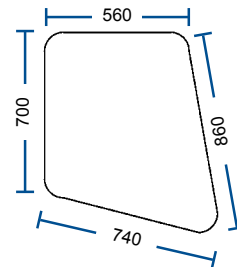

41/4020-22
(31023000)

Gauche / *LH*
Droit / *RH*

Fenêtre arrière / *Rear window*

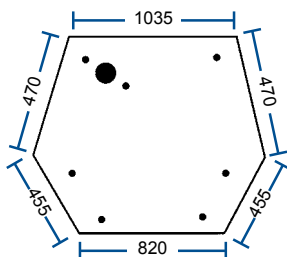

41/4071-27
(30942200)

8 Trous / *Holes*

Fenêtre latérale / *Side window*

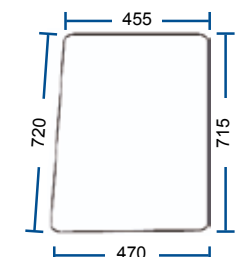

41/4047-56
(30753700)

Gauche / *LH*
Droit / *RH*

Les références des pièces sont indicatives.
Nos pièces ne sont pas d'origine

*Part numbers are quoted for reference purposes only.
Our parts and accessories are not original.*



VITRERIE DE CABINE
CAB GLASS

505, 605, 705, 805, 905

Vitres teintées / *Tinted glass*

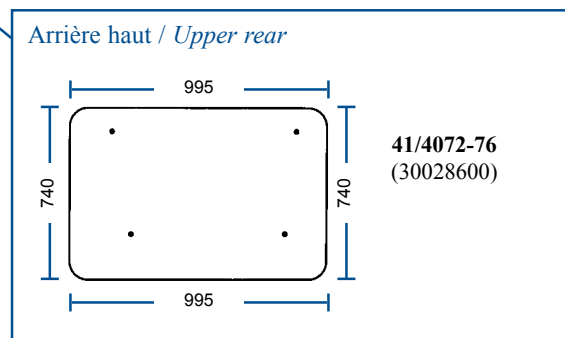
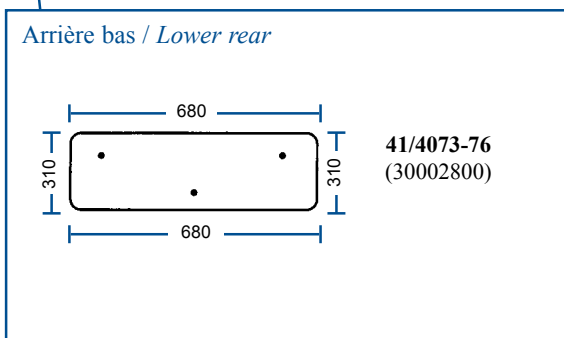
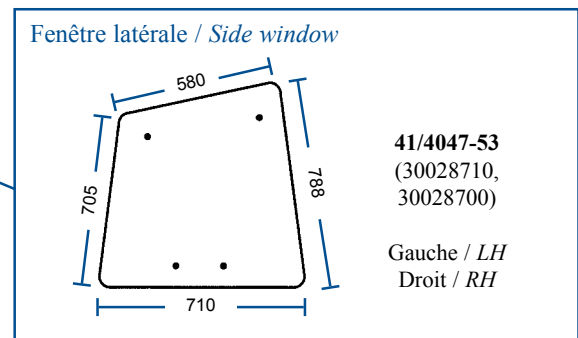
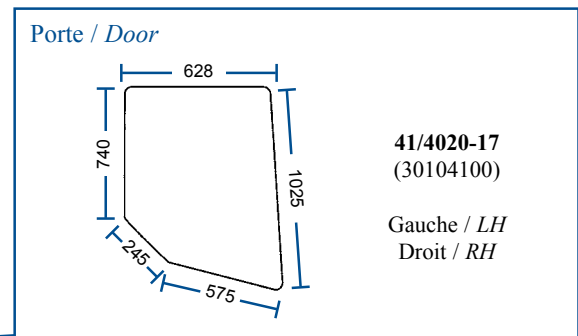
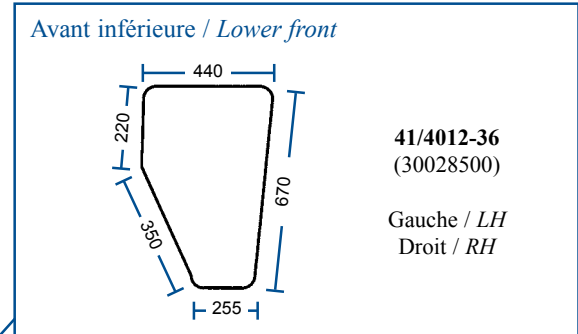
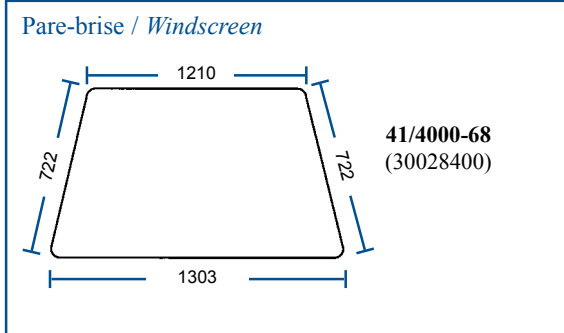

Les références des pièces sont indicatives.
Nos pièces ne sont pas d'origine

Part numbers are quoted for reference purposes only.
Our parts and accessories are not original.



VITRERIE DE CABINE
CAB GLASS

600, 700, 800, 865, 900

Vitres teintées / *Tinted glass*

Pare-brise / *Windscreen*

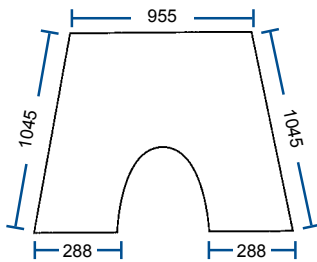

41/4000-67
(33118200)

Avant inférieure / *Lower front*

41/4015-3
(33118000)

Gauche / *LH*

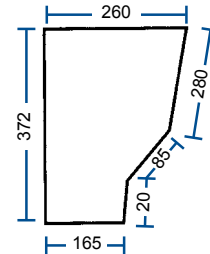

41/4016-3
(33118100)

Droit / *RH*



Fenêtre arrière / *Rear window*

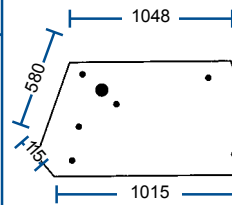

41/4071-26
(33118900) (a)

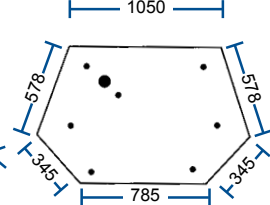

41/4071-25
(33118300)

Fenêtre latérale / *Side window*

41/4047-54
(32993900)

Gauche / *LH*

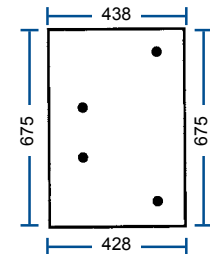

41/4047-55
(33191200)

Droit / *RH*

Porte haut / *Top door*

41/4034-4
(33191000)

Gauche / *LH*

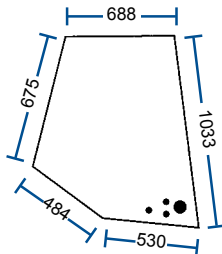

41/4035-4
(32993700)

Droit / *RH*

Porte bas / *Lower door*

41/4037-2
(33191100)

Gauche / *LH*

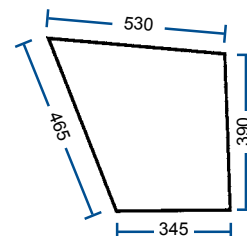

41/4036-2
(32993800)

Droit / *RH*

(a) Cabine forestière / *Fits Forrestry cab*

Les références des pièces sont indicatives.
Nos pièces ne sont pas d'origine

Part numbers are quoted for reference purposes only.
Our parts and accessories are not original.



"THE RELIABLE SERVICE"



VITRERIE DE CABINE
CAB GLASS

6000, 6100, 6200, 6250, 6300, 6350, 6400, 6550, 6600,
6650, 6850, 6800, 6900, 8000, 8050, 8100, 8150, 8200,
8400, 8450, 8550, 8750, 8950

Vitres teintées / *Tinted glass*

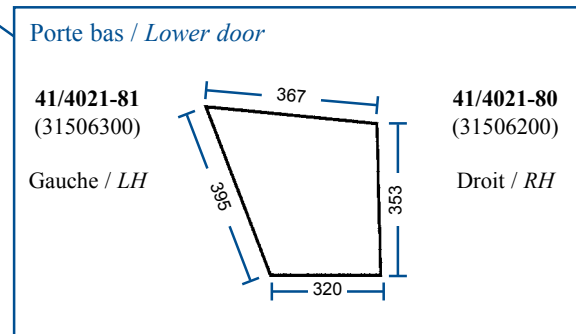
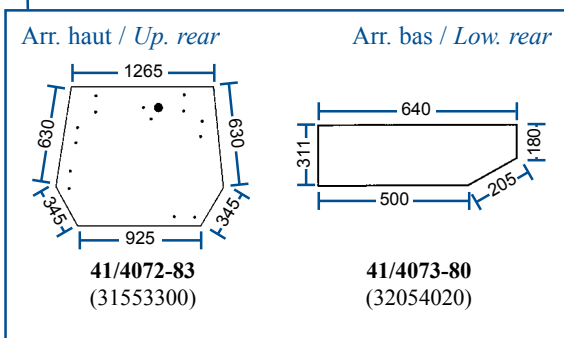
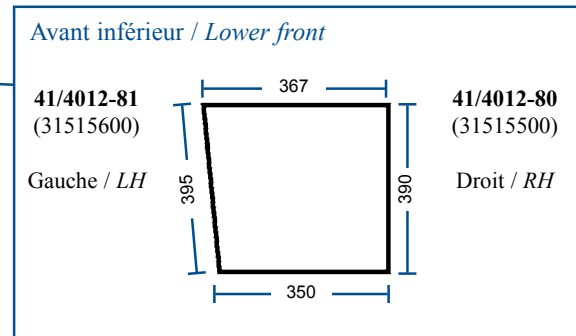
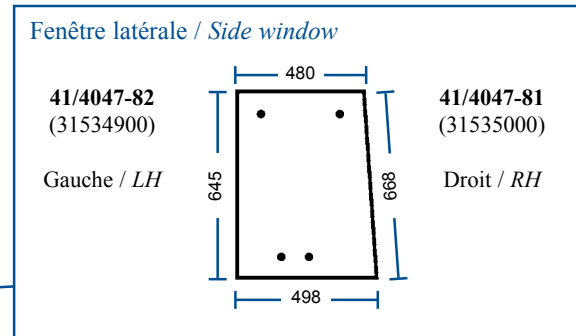
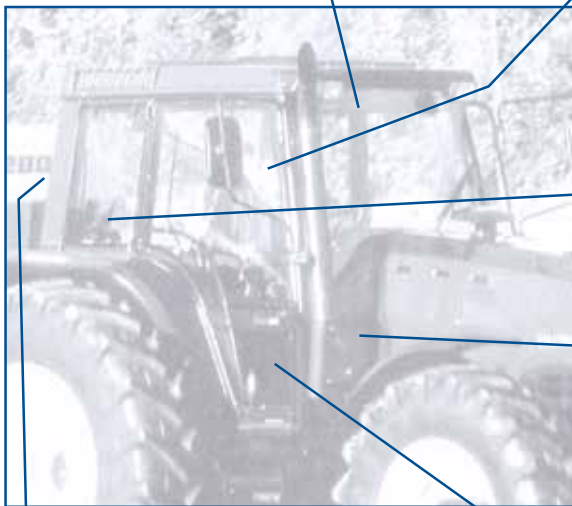
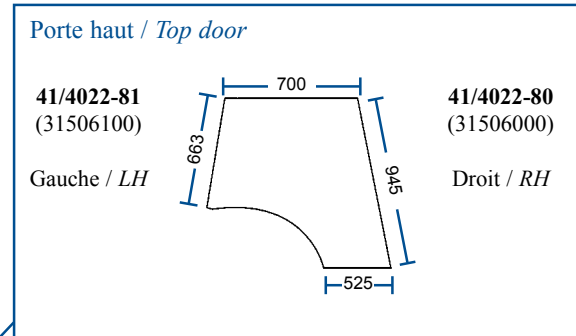
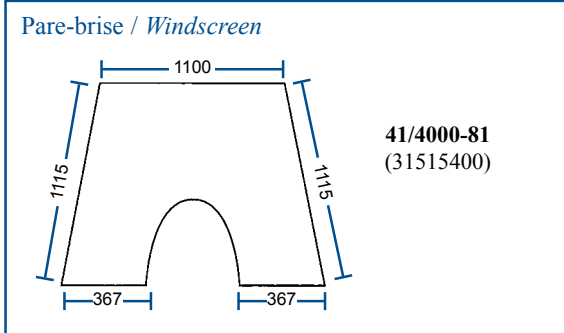

Les références des pièces sont indicatives.
Nos pièces ne sont pas d'origine

Part numbers are quoted for reference purposes only.
Our parts and accessories are not original.



RÉFÉRENCES INTERCHANGEABLES CROSS REFERENCES

OEM OEM	Réf. Ref.	Page Page	OEM OEM	Réf. Ref.	Page Page	OEM OEM	Réf. Ref.	Page Page	OEM OEM	Réf. Ref.	Page Page
33426	117-305	14	20236409	161-145	23, 24, 25	30302108	1987-18	52	31798600	495-142	45
303430	221-908	33, 34	20238200	161-148	24, 25	30314200	870-99	52	31798610	495-142	45
328704	181-101	30	20238210	161-148	24, 25	30324300	303-103	36	31800500	6407-76	42
336241	227-17	35, 39	20238300	162-148	24, 25	30342900	200-900	32, 33, 34	31800600	6407-78	42
411020	417-12	40	20238310	162-148	24, 25	30343400	154-150	18	31813100	303-106	36
411040	423-9	40	20246089	161-146	24, 25	30343500	153-142	18	31851700	640-301	46
412810	419-5	40	20252235	162-146	24, 25	30355700	165-119	21	31852310	640-305	46
412960	418-4	40	20307790	111-300	23, 25	30400630	6400-70	42	31852330	640-37	46
466987	111-56	23, 24, 25	20310944	111-301	23, 25	30400730	6400-71	42	31877500	967-89	28
582970	231-903	32	20315106	111-302	23, 25	30405210	495-144	45	31882200	495-147	45
582990	231-902	32	20321343	111-56	23, 24, 25	30405610	495-143	45	31882210	495-148	45
586480	167-118	22	20331343	111-56	23, 24, 25	30410800	240-77	23, 25	31887800	221-901	33, 34
589680	1995-2	26	20339371	111-4	23, 24, 25	30418100	411-19	39	31939610	641-24	23, 24, 25
590780	958-73	27	20340251	111-83	23, 25	30418200	414-19	39	31952500	495-141	45
609404	497-136	44	20359300	111-303	25	30581200	850-5	52	31955600	585-32	43
609408	495-135	44	20359302	111-91	25	30606000	240-78	23, 25	31970500	200-906	32, 34
609409	495-136	44	20410800	240-77	23, 25	30629900	278-11	37	31970510	200-906	32, 34
616790	153-109	18	20410800	97-71	23, 25	30630000	280-3	37	31975300	227-15	35
616800	154-111	18	20531100	4200-40	25	30752800	4000-69	53	32043000	212-900	32, 34
619400	186-10	27	20531300	4200-42	25	30752900	4012-48	53	32043110	200-904	32, 34
619670	958-72	27	20539500	4200-41	25	30753700	4047-56	53	32082500	1919-134	30
619680	958-71	27	20606000	240-78	23, 25	30754300	200-903	32, 34	32082600	1913-123	31
619953	181-100	30	20624510	641-300	23, 25	30942200	4071-27	53	32095900	107-300	16
649371	177-70	16	20626500	641-21	23, 25	30943900	967-90	28	32241400	871-40	52
655835	440-60	41	20639600	641-23	24, 25	30943900	967-91	28	32263500	585-31	43
661910	226-22	35, 39	20639610	641-24	23, 24, 25	30943900	967-96	29	32276400	966-2	27
661911	226-23	35, 39	30002200	495-137	44	30944000	967-97	29	32276400	967-94	28
662220	479-101	41	30002800	4073-76	54	30944100	967-99	29	32276400	967-95	28
662362	414-18	39	30014500	303-67	38	30944200	967-101	29	32297200	967-102	29
663240	227-16	35, 39	30014510	303-66	38	30944200	967-102	29	32433810	191-7	16
666230	228-17	35	30021810	6301-1	38	30944200	967-103	29	32433910	191-9	16
671050	421-30	39	30021820	6301-2	38	30944200	967-98	29	32438900	191-10	16
671441	440-61	41	30028400	4000-68	54	30944800	967-96	29	32519000	1988-54	51
674230	1918-133	30	30028600	4072-76	54	30944900	967-97	29	32553200	950-69	27
686300	651-1	46	30028700	4047-53	54	30945000	967-99	29	32589800	167-117	22
691210	229-17	35	30028710	4047-53	54	30945100	967-101	29	32597700	221-900	32, 33, 34
698940	495-137	44	30030000	317-50	37	30960700	212-901	32, 34	32599200	165-165	21
718010	200-906	32, 34	30030100	316-50	37	30960900	221-903	32, 34	32611000	150-149	17
720720	341-70	42	30036400	200-905	32, 34	31009310	165-118	21	32639400	221-904	32, 34
720885	495-146	45	30040000	303-104	36	31023000	4020-22	53	32711900	851-12	52
720886	495-145	45	30049200	221-905	32, 34	31026500	641-21	23, 25	32729810	1988-55	51
721005	6403-100	43	30049210	221-905	32, 34	31059800	497-137	45	32729820	1988-55	51
723554	221-907	32, 34	30049220	221-907	32, 34	31059900	495-139	45	32733300	967-92	28
730680	585-33	43	30049300	221-906	32, 34	31062710	6408-70	42	32738800	850-7	52
731310	640-300	46	30068900	150-127	17	31069300	585-35	43	32831300	221-902	33, 34
731320	640-301	46	30077200	870-96	52	31132410	440-60	41	32831400	200-901	33, 34
731430	640-302	46	30100200	1912-91	31	31372000	6407-70	42	32862400	967-98	29
731900	640-302	46	30100800	950-70	27	31372400	495-140	45	32863100	640-307	46
813140	6800-2	35, 39	30101100	961-21	26	31517900	872-66	52	32875400	850-6	52
814050	212-902	32, 34	30104100	4020-17	54	31539600	641-23	24, 25	32887200	967-91	28
816450	950-69	27	30107700	154-112	18	31539610	641-24	23, 24, 25	32887400	967-90	28
820230	421-31	39	30107800	153-110	18	31540600	1912-92	31	32887500	967-89	28
821030	495-300	44	30114100	850-6	52	31540700	1918-134	30	32905600	640-300	46
827480	495-138	44	30127200	850-5	52	31597300	231-900	33	32993700	4035-4	55
889810	200-906	32, 34	30127200	850-7	52	31631300	870-97	52	32993800	4036-2	55
3039700	341-70	42	30181500	413-19	39	31636900	1931-35	31	32993900	4047-54	55
3426255	497-139	45	30184800	422-19	40	31636910	1931-34	31	32995000	870-104	52
3426276	495-149	45	30191700	872-65	52	31679810	151-25	17	33009500	967-93	28
1628494M1	1955-453	31	30208100	231-904	32, 34	31691800	1988-52	51	33009800	967-93	28
20107806	97-70	23, 25	30221800	6293-3	37	31709010	967-100	29	33028310	162-148	24, 25
20136342	97-73	23, 24, 25	30225110	640-303	46	31709100	967-92	28	33031410	226-15	35
20136346	97-72	23, 24, 25	30225120	640-304	46	31781000	967-100	29	33038200	161-148	24, 25
20136459	97-34	24, 25	30228500	4012-36	54	31790500	6407-77	42	33038300	162-148	24, 25
20147133	97-33	24, 25	30247400	441-61	41	31795100	6407-77	42	33118000	4015-3	55
20219771	161-180	23, 25	30247600	151-24	17	31795900	6408-74	42	33118000	4071-25	55
20228300	161-128	23, 24, 25	30260801	181-101	30	31795910	6408-75	42	33118100	4016-3	55
20228310	161-128	23, 24, 25	30263910	6293-2	37	31796200	440-62	41	33118200	4000-67	55
20228400	162-128	23, 24, 25	30272600	1913-122	31	31797500	585-30	43	33118900	4071-26	55
20228410	162-128	23, 24, 25	30279900	167-119	22	31797510	585-34	43	33191000	4034-4	55
20228654	161-144	23, 25	30294600	410-19	39	31798510	497-138	45	33191100	4037-2	55
20228655	162-144	23, 24, 25	30294920	165-115	21	31798520	497-138	45	33191200	4047-55	55

Les références des pièces sont indicatives.
Nos pièces ne sont pas d'origine

Part numbers are quoted for reference purposes only.
Our parts and accessories are not original.



"THE RELIABLE SERVICE"



**RÉFÉRENCES INTERCHANGEABLES
CROSS REFERENCES**

OEM OEM	Réf. Ref.	Page Page	OEM OEM	Réf. Ref.	Page Page	OEM OEM	Réf. Ref.	Page Page	OEM OEM	Réf. Ref.	Page Page
33223300	967-94	28	836117564	43-303	11	836640128	920-71	49	F35807231	161-77	24, 25
33223400	967-95	28	836117910	45-300	12	836640251	111-83	23, 25	F35807241	162-77	24, 25
33508700	1988-53	51	836117970	15-25	6	836640289	71-304	13	JB8205	441-62	41
33561800	640-307	46	836119431	145-33	20	836640290	70-316	13	JB8206	441-60	41
33564400	640-37	46	836119457	2-301	6	836640292	30-306	8	KH1065	429-30	39
33899641	1912-200	31	836119459	6-301	6	836640356	70-304	13	KH1111	429-31	39
34123900	423-86	40	836119849	147-10	20	836640358	30-302	8	KH1158	6408-72	42
34306100	640-305	46	836122443	73-301	13	836640772	180-14	26	KH1161	6407-74	42
34401400	422-86	40	836122886	66-16	22	836640927	920-71	49	KH1163	6407-73	42
70003700	303-105	36	836128125	73-302	13	836640932	100-69	15	KH1164	250-30	37
70017100	107-300	16	836128134	74-301	13	836640940	930-44	49	KH1191	305-40	36
70031500	258-30	37	836128654	161-144	23, 25	836646271	28-302	6	KH1209	6407-71	42
70043010	265-30	37	836128655	162-144	23, 24, 25	836646356	42-302	11	KH1213	6407-72	42
70044800	258-31	37	836129728	75-302	13	836646357	43-302	11	KH1214	6408-71	42
70044900	259-30	37	836131348	100-303	15	836646360	74-303	13	KH1215	6408-73	42
70057500	958-70	27	836131370	71-302	13	836646380	45-302	12	KH1216	6407-75	42
714580	1919-133	30	836131371	70-302	13	836647133	97-33	24, 25	KH1228	305-42	36
80381900	303-104	36	836136051	41-300	11	836647420	35-302	9, 10	KH1405	305-41	36
83649465	46-300	12	836136109	161-145	23, 24, 25	836647502	37-301	9	KH3275	692-56	47
836647503	37-301	9	836136220	130-123	19	836647502	38-305	7	KH3300	692-51	47
614105880	11-301	7	836136342	97-73	23, 24, 25	836647503	38-302	7	KH3305	692-50	47
614602415	47-300	11	836136409	161-145	23, 24, 25	836647600	46-303	12	KH3306	692-53	47
615570812	119-6	14	836139012	100-303	15	836647601	41-301	11	KH3316	692-55	47
654271208	180-13	19, 26	836139423	30-202	8	836647936	46-302	12	KH3317	692-57	47
684121275	144-400	20	836140036	30-201	8	836655269	33-303	9, 10	KH3319	692-52	47
684121300	144-402	20	836146089	161-146	24, 25	836655395	73-304	13	KH3320	692-54	47
684121325	144-401	20	83616441	131-124	19	836655536	2-301 A	6	L30208	479-100	41
684121400	144-405	20	836322183	75-303	13	836655537	2-301 B	6	LA1992	304-29	38
684121425	144-404	20	836322898	74-300	13	836659391	100-69	15	LA5013	479-100	41
684121600	144-406	20	836328734	43-303	11	836659580	100-69	15	LA9011	304-30	37
807201671	162-77	24, 25	836328735	42-303	11	836659702	32-310	9, 10	LA9016	477-102	41
807201672	161-77	24, 25	836329632	147-11	20	836740280	71-303	13	LA9017	477-103	41
835311677	33-302	9, 10	836330700	33-301	9, 10	836740281	70-303	13	T50009	1988-51	51
835322233	38-304	7	836331590	143-37	20	836740287	30-305	8	T50010	1988-50	51
835322787	35-301	9, 10	836331747	71-318	13	836740288	30-307	8			
835331101	117-304	14	836331748	70-318	13	836740333	70-317	13			
835331343	111-56	23, 24, 25	836336459	97-34	24, 25	836740334	30-303	8			
835331372	131-123	19	836339087	117-300	14	836746354	73-303	13			
835331592	930-43	49	836339201	34-301	9, 10	836746362	74-302	13			
835336903	38-301	7	836339296	71-321	13	836754665	100-304	15			
835339234	130-122	19	836339371	111-4	23, 24, 25	836764215	130-229	19			
835339304	920-10	49	836339671	70-321	13	836840101	131-158	19			
835339425	131-301	19	836339723	131-159	19	836840237	71-319	13			
836006501	3-300	6	836339985	117-300	14	836840238	70-319	13			
836006502	28-300	6	836340017	100-303	15	836840241	30-308	8			
836006574	44-301	12	836340257	131-159	19	836840596	32-309	9, 10			
836006671	2-300	6	836340268	30-304	8	836840627	131-300	19			
836006704	75-300	13	836429729	75-301	13	836840795	30-309	8			
836007781	100-301A	15	836431349	100-301	15	836847465	130-230	19			
836010480	38-303	7	836431368	71-301	13	836852235	162-146	24, 25			
836010936	117-303	14	836431973	70-320	13	836854739	100-305	15			
836012114	100-302	15	836436346	97-72	23, 24, 25	836854757	117-305	14			
836015156	143-33	20	836439059	100-301	15	836854832	117-306	14			
836022081	54-300	11	836440085	30-301	8	836862101	30-310	8			
836038476	38-300	7	836529950	43-300	11	836864481	130-230	19			
836039027	30-200	8	836529951	42-300	11	836864484	130-231	19			
836107726	75-304	13	836531922	32-300	9, 10	887283760	186-10	27			
836110153	42-301	11	836536630	73-300	13	899901495	119-5	14			
836110233	34-302	9, 10	836536797	97-71	23, 25	936336459	97-34	24, 25			
836110552	3-301	6	836536827	35-300	9, 10	3300726720	851-10	52			
836110646	28-301	6	836539010	34-300	9, 10	33030213000	191-8	16			
836112632	6-300	6	836539064	131-121	19	33614100002	13-301	7			
836112762	3-301 A	6	836539065	71-300	13	33654271209	180-30	26			
836112763	3-301 B	6	836539872	100-300	15	836859302	111-91	25			
836115489	143-34	20	836540084	30-300	8	ADB145M34447	117-306	14			
836115646	143-35	20	836589066	70-315	13	F20321	441-60	41			
836115718	143-36	20	836639957	117-301	14	F33030211	871-41	52			
836115971	131-122	19	836640073	33-304	9, 10	F33853161	872-67	52			
836115972	131-160	19	836640074	33-304	9, 10	F33867011	625-7	24, 25			
836117378	15-26	6	836640078	34-303	9, 10	F33888402	4200-25	25			
836117423	46-301	12	836640126	34-302	9, 10	F33895561	870-98	52			

Les références des pièces sont indicatives.
Nos pièces ne sont pas d'origine

Part numbers are quoted for reference purposes only.
Our parts and accessories are not original.



"THE RELIABLE SERVICE"



INDEX DES RÉFÉRENCES REFERENCE INDEX

Réf. Ref.	Page Page	Réf. Ref.	Page Page	Réf. Ref.	Page Page	Réf. Ref.	Page Page
2-300	6	54-300	11	130-229	19	191-10	16
2-301	6	60-300	14	130-230	19	198-21	35
2-301 A	6	60-301	14	130-231	19	200-900	32, 33, 34
2-301 B	6	66-16	22	131-121	19	200-901	33, 34
3-300	6	70-302	13	131-122	19	200-902	32
3-301	6	70-303	13	131-123	19	200-903	32, 34
3-301 A	6	70-304	13	131-124	19	200-904	32, 34
3-301 B	6	70-315	13	131-158	19	200-905	32, 34
6-300	6	70-316	13	131-159	19	200-906	32, 34
6-301	6	70-317	13	131-160	19	212-900	32, 34
11-301	7	70-318	13	131-300	19	212-901	32, 34
13-301	7	70-319	13	131-301	19	212-902	32, 34
15-25	6	70-320	13	143-33	20	221-900	32, 33, 34
15-26	6	70-321	13	143-34	20	221-901	33, 34
28-300	6	71-300	13	143-35	20	221-902	33, 34
28-301	6	71-301	13	143-36	20	221-903	32, 34
28-302	6	71-302	13	143-37	20	221-904	32, 34
30-200	8	71-303	13	144-303	20	221-905	32, 34
30-201	8	71-304	13	144-400	20	221-906	32, 34
30-202	8	71-318	13	144-401	20	221-907	32, 34
30-300	8	71-319	13	144-402	20	221-908	33, 34
30-301	8	71-321	13	144-404	20	226-15	35
30-302	8	73-300	13	144-405	20	226-22	35, 39
30-303	8	73-301	13	144-406	20	226-23	35, 39
30-304	8	73-302	13	145-33	20	227-15	35
30-305	8	73-303	13	147-10	20	227-16	35, 39
30-306	8	73-304	13	147-11	20	227-17	35, 39
30-307	8	74-300	13	150-127	17	228-17	35
30-308	8	74-301	13	150-149	17	229-17	35
30-309	8	74-302	13	151-24	17	230-900	32
30-310	8	74-303	13	151-25	17	230-901	32, 33
32-300	9, 10	75-300	13	153-109	18	231-900	33
32-309	9, 10	75-301	13	153-110	18	231-902	32
32-310	9, 10	75-302	13	153-142	18	231-903	32
33-301	9, 10	75-303	13	154-111	18	231-904	32, 34
33-302	9, 10	75-304	13	154-112	18	240-77	23, 25
33-303	9, 10	97-33	24, 25	154-150	18	240-78	23, 25
33-304	9, 10	97-34	24, 25	161-77	24, 25	250-30	37
34-300	9, 10	97-70	23, 25	161-128	23, 24, 25	258-30	37
34-301	9, 10	97-71	23, 25	161-144	23, 25	258-31	37
34-302	9, 10	97-72	23, 24, 25	161-145	23, 24, 25	259-30	37
34-303	9, 10	97-73	23, 24, 25	161-146	24, 25	265-30	37
35-300	9, 10	100-69	15	161-148	24, 25	278-11	37
35-301	9, 10	100-300	15	161-148	24, 25	280-3	37
35-302	9, 10	100-301	15	161-180	23, 25	303-66	38
37-301	9	100-301A	15	162-77	24, 25	303-67	38
38-300	7	100-302	15	162-128	23, 24, 25	303-103	36
38-301	7	100-303	15	162-144	23, 24, 25	303-104	36
38-302	7	100-304	15	162-146	24, 25	303-105	36
38-303	7	100-305	15	162-148	24, 25	303-106	36
38-304	7	107-300	16	165-115	21	304-29	38
38-305	7	111-300	23, 25	165-118	21	304-30	37
41-300	11	111-301	23, 25	165-119	21	305-40	36
41-301	11	111-302	23, 25	165-165	21	305-41	36
42-300	11	111-302	23, 25	167-117	22	305-42	36
42-301	11	111-303	25	167-118	22	316-50	37
42-302	11	111-4	23, 24, 25	167-119	22	317-50	37
42-303	11	111-56	23, 24, 25	168-300	25	341-70	42
43-300	11	111-83	23, 25	168-301	25	404-100	39
43-302	11	111-91	25	168-302	25	409-50	40
43-303	11	117-300	14	177-70	16	410-19	39
44-301	12	117-301	14	180-13	19, 26	411-19	39
45-300	12	117-303	14	180-14	26	413-19	39
45-302	12	117-304	14	180-30	26	414-18	39
46-300	12	117-305	14	181-100	30	414-19	39
46-301	12	117-306	14	181-101	30	417-12	40
46-302	12	119-5	14	186-10	27	418-4	40
46-303	12	119-6	14	191-7	16	419-5	40
47-300	11	130-122	19	191-8	16	421-30	39
		130-123	19	191-9	16		

Les références des pièces sont indicatives.
Nos pièces ne sont pas d'origine

Part numbers are quoted for reference purposes only.
Our parts and accessories are not original.



"THE RELIABLE SERVICE"



INDEX DES RÉFÉRENCES REFERENCE INDEX

Réf. Ref.	Page Page	Réf. Ref.	Page Page	Réf. Ref.	Page Page	Réf. Ref.	Page Page
421-31	39	692-55	47	1931-28	31	6301-1	38
422-19	40	692-56	47	1931-29	31	6301-2	38
422-86	40	692-57	47	1931-33	31	6400-70	42
423-9	40	700-57	48	1931-34	31	6400-71	42
423-86	40	700-58	48	1931-35	31	6403-100	43
429-30	39	700-59	48	1955-245	30	6407-70	42
429-31	39	700-60	48	1955-380	31	6407-71	42
429-32	39	700-61	48	1955-382	30, 31	6407-72	42
440-60	41	735-7	48	1955-453	31	6407-73	42
440-61	41	735-8	48	1987-18	52	6407-74	42
440-62	41	735-8A	48	1988-50	51	6407-75	42
441-60	41	760-100	48	1988-51	51	6407-76	42
441-61	41	760-101	48	1988-52	51	6407-77	42
441-62	41	830-971	50	1988-53	51	6407-78	42
460-100	41	830-984	50	1988-54	51	6408-70	42
460-101	41	850-5	52	1988-55	51	6408-71	42
460-102	41	850-6	52	1995-2	26	6408-72	42
475-100	41	850-7	52	1995-410	30	6408-73	42
475-102	41	851-10	52	2930-57	21	6408-74	42
477-100	41	851-11	52	2930-76	21	6408-75	42
477-102	41	851-12	52	3102-300	50	6800-2	35, 39
477-103	41	870-96	52	3102-301	50		
479-100	41	870-97	52	3102-302	50		
479-101	41	870-98	52	3102-303	50		
495-135	44	870-99	52	3102-304	50		
495-136	44	870-104	52	3102-305	50		
495-137	44	871-40	52	3102-306	50		
495-138	44	871-41	52	3102-307	50		
495-139	45	872-65	52	3102-308	50		
495-140	45	872-66	52	3102-309	50		
495-141	45	872-67	52	3102-310	50		
495-142	45	920-10	49	3102-311	50		
495-143	45	920-71	49	3102-312	50		
495-144	45	920-108	49	3102-313	50		
495-145	45	920-162	49	3102-314	50		
495-146	45	930-43	49	3102-315	50		
495-147	45	930-44	49	3102-316	50		
495-148	45	950-69	27	3102-317	50		
495-149	45	950-70	27	3102-318	50		
495-300	44	958-71	27	3102-319	50		
497-136	44	958-72	27	3102-320	50		
497-137	45	958-73	27	4000-67	55		
497-138	45	961-20	26	4000-68	54		
497-139	45	961-21	26	4000-69	53		
585-30	43	966-2	27	4012-36	54		
585-31	43	967-89	28	4012-48	53		
585-32	43	967-90	28	4015-3	55		
585-33	43	967-91	28	4016-3	55		
585-34	43	967-92	28	4020-17	54		
585-35	43	967-93	28	4020-22	53		
625-7	24, 25	967-94	28	4034-4	55		
640-37	46	967-95	28	4035-4	55		
640-300	46	967-96	29	4036-2	55		
640-301	46	967-97	29	4037-2	55		
640-302	46	967-98	29	4047-53	54		
640-303	46	967-99	29	4047-54	55		
640-304	46	967-100	29	4047-55	55		
640-305	46	967-101	29	4047-56	53		
640-307	46	967-102	29	4071-25	55		
641-21	23, 25	967-103	29	4071-26	55		
641-23	24, 25	1912-91	31	4071-27	53		
641-24	23, 24, 25	1912-92	31	4072-76	54		
641-300	23, 25	1912-200	31	4073-76	54		
651-1	46	1913-122	31	4200-25	25		
692-50	47	1913-123	31	4200-40	25		
692-51	47	1913-124	31	4200-41	25		
692-52	47	1918-133	30	4200-42	25		
692-53	47	1918-134	30	6293-2	37		
692-54	47	1919-133	30	6293-3	37		

Les références des pièces sont indicatives.
Nos pièces ne sont pas d'origine

Part numbers are quoted for reference purposes only.
Our parts and accessories are not original.



"THE RELIABLE SERVICE"



**BEPCO PARTS SA****HERMALLE-SOUS-HUY**

Rue Chaumont, 4D • 4480 Hermalle-sous-Huy • Belgique
T +32 85 24 54 00 • F +32 85 24 54 50
info.be@bepcoparts.com • www.bepcoparts.com

VILLERS-LE-BOUILLET

Rue de Waremme, 114 • 4530 Villers-le-Bouillet • Belgique
T +32 85 24 54 00 • F +32 85 24 54 50
info.be@bepcoparts.com • www.bepcoparts.com

**BEPCO UK LTD**

Bepco House • Unit 316 • Hartlebury Trading Estate
Hartlebury - Worcestershire, DY10 4JB (UK)
P +44 (0)1299 252270 • F 0800 216553
info@bepcoparts.com • www.bepcoparts.com

**BEPCO FRANCE SAS**

Z.I. La Plaine, Allée de Bigorre
BP80041 Le Passage • 47901 Agen Cedex 9 • France
T +33 (0)553 96 31 25 • F +33 (0)553 68 03 72
info.fr@bepcoparts.com • www.bepcoparts.com

VILLENEUVE-SUR-LOT

294 Av. de Bordeaux • CS 30059 Bias
FR-47302 Villeneuve sur lot • France
T +33 (0)5 53 40 37 50 • F +33 (0)5 53 70 61 93

JANZÉ

P.A. de la Chauvelière • Rue Charles Lindbergh
35150 JANZE • France
T + 33 (0)2 99 44 16 18 • F +33 (0)2 99 44 17 29

**TVH AUSTRALASIA PTY LTD**

HEAD OFFICE BRISBANE • www.bepcoparts.com

ADELAIDE

96 South Terrace • Wingfield SA 5013
Free 1800 182 344 • T +61 8 8359 8933 • F +61 8 8234 2212
BepcoSAsales@tvh.com.au

BRISBANE

735 Boundary Road • Richlands QLD 4077
Free 1800 020 082 • T +61 7 3344 1113 • F +61 7 3344 1332
BepcoQLDsales@tvh.com.au

MELBOURNE

7/66-74 Micro Circuit • Dandenong South VIC 3175
Free 1800 802 367 • T +61 3 9796 5422 • F +61 3 9796 5251
BepcoVICsales@tvh.com.au

PERTH

2/15 Colin Jamieson Drive • Welshpool WA 6106
Free 1800 182 344 • T +61 8 8352 8984 • F +61 8 8234 2212
BepcoWAsales@tvh.com.au

SYDNEY

1/1002-1010 Canley Vale Rd • Wetherill Park NSW 2164
Free 1800 808 827 • T +61 2 6885 5288 • F +61 3 9796 5251
BepcoNSWsales@tvh.com.au

**TVH NEW ZEALAND LTD****AUCKLAND**

PO Box 51490 • Pakuranga 2140 • 11K Echelon Place
East Tamaki • Auckland
Free 0800 459 662 • T +64 9 274 9695 • F +64 9 274 9698
info@tvh.co.nz • www.tvh.com

CHRISTCHURCH

11C Parkhouse Road
Wigram • Christchurch 8042
Free 0508 8 722 867 • T +64 3 550 1298 • F +64 3 974 9993
infochch@tvh.co.nz

**BEPCO DEUTSCHLAND GmbH**

Neuer Weg 5 • 59505 Bad Sassendorf • Germany
T +49 (0)2927 919 59 0 • F +49 (0)2927 919 59 59
info.de@bepcoparts.com • www.bepcoparts.com

**BEPCO NEDERLAND BV**

Den Dolvert 10 • 5473 GP, Heeswijk-Dinther • Nederland
T +31 (0)413 29 39 75 • F +31 (0)413 29 40 87
info.nl@bepcoparts.com • www.bepcoparts.com

**BEPCO IBÉRICA SA**

C/ Torrent de Vallmajor, 82
08915 Badalona (Barcelona) • Spain
T +34 (0)902 111 062 - 933 810 062 • F +34 (0)933 813 345
info.es@bepcoparts.com • www.bepcoparts.com

ALMENDRALEJO

Ctra. Badajoz - Pol. «Rayvaz» Nave 21
06200 Almendralejo (Badajoz)
T +34 (0)902 111 062 - 924 664 890
F +34 (0)924 664 576

DOS HERMANAS

Pol. Ind. La Isla, C/ Hornos, 11
41703 Dos Hermanas (Sevilla)
T +34 (0)902 111 062 - 954 931 546
F +34 (0)954 930 130

SANTIAGO DE COMPOSTELA

Pol. El Tambre, Via Faraday, 36
15890 Santiago de Compostela
T +34 (0)902 111 062 - 981 560 012
F +34 (0)981 557 753

**TVH PARTS SOUTH AFRICA (Pty) Ltd**

HEAD OFFICE JOHANNESBURG • www.tvh.com

CAPE TOWN

1 Karee Street • Kraaifontein Industries • Cape Town 7571
T +27 21 988 2432 • F +27 21 988 9127
capetownsales@tvh.com

DURBAN

2 Monaco Place • Westmead • Pinetown 3600
T +27 31 100 0760 • F +27 31 700 6191
durbansales@tvh.com

JOHANNESBURG

90 Electron Avenue • Isando • Kempton Park 1601
T +27 11 281 27 00 • F +011 974 9845
johannesburgsales@tvh.com

LICHTENBURG

Shop 1 • 109 Scholtz Street • Lichtenburg 2740
T +27 18 632 6192/6092 • F +27 18 632 6108
lichtenburgsales@tvh.com

PORT ELIZABETH

134 Kempston Road • Korsten • Port Elizabeth 6020
T +27 41 453 1404/8 • F +27 41 453 1409
portelizabethsales@tvh.com

FOR ALL OUR LATEST CATALOGUE UPDATES AND COMPANY INFO: WWW.BEPCOPARTS.COM



The spare parts mentioned in this list can normally be delivered from stock. In addition, we can supply parts, which are not mentioned in this catalogue, with the shortest possible delivery time. The O.E.M. references are only for indication purposes and do not imply that the spare parts are coming from the manufacturer. This spare parts list can be modified without prior notice. All photographs, drawings, illustrations, brand names, descriptions and numbers are included for identification purposes only.



De onderdelen vermeld in deze lijst, zijn normaal uit voorraad leverbaar, behoudens uitverkocht. Ook niet-vermelde onderdelen kunnen binnen de kortste tijd uitgeleverd worden. De O.E.M. referenties dienen enkel ter indicatie en impliceren niet dat deze van de vermelde constructeur afkomstig zijn. Deze onderdelenlijst kan zonder enige voorafgaande verwittiging aangepast worden. Alle gebruikte foto's, tekeningen, afbeeldingen, merknamen, omschrijvingen en nummers dienen alleen ter identificatie.



Les pièces de rechange, mentionnées dans cette liste, sont normalement livrables du stock. En plus, les articles non indiqués peuvent être fournis en peu de temps. Cette liste peut être modifiée sans avis préalable. Les références O.E.M. sont seulement indicatives et n'impliquent pas que les pièces de rechange viennent du constructeur. Toutes les photographies, illustrations, marques, descriptions, tous les plans et numéros servent exclusivement à une identification.



Die in dieser Liste aufgeführten Teile sind normalerweise aus dem Lager lieferbar. Wir sind zudem in der Lage nicht aufgeführte Teile innerhalb kürzester Zeit zu liefern. Die O.E.M. Referenznummern dienen zur Information und beinhalten nicht, dass diese vom genannten Hersteller kommen. Diese Bestandsliste kann ohne vorhergehende Ankündigung geändert werden. Alle verwendeten Foto's, Zeichnungen, Abbildungen, Markennamen, Beschreibungen und Nummern dienen nur zu Identifikationszwecken.



Los artículos mencionados en este catálogo se encuentran habitualmente en stock. Además, podemos suministrar en un plazo corto de tiempo otros artículos relacionados que no se encuentren expresamente mencionados en este catálogo. Las referencias O.E.M. sirven sólo como indicación y no implican que procedan del constructor. Este listado de productos puede estar sujeto a modificaciones sin aviso previo. Todas las fotos, dibujos, ilustraciones, nombres de marca, descripciones y números se han incluido simplemente con el propósito de su identificación.



I pezzi di ricambio, menzionati in questo listino, possono essere forniti con una consegna immediata a condizione che non siano esauriti. I pezzi di ricambio non menzionati possono essere forniti in poco tempo. Le referenze O.E.M. sono solamente indicative e non implicano che i pezzi di ricambio vengano da questo costruttore. Questa lista ricambi può essere aggiustata senza avvisi anticipati. Tutti i numeri, codici, nomi, foto, spaccati e disegni sono solo a titolo informativo.



Części z tego katalogu są zazwyczaj na stanie magazynowym. Również części które nie są wyszczególnione w katalogu mogą być dostarczone na zamówienie w najkrótszym możliwym terminie. Opis części O.E.M. jest używany informacyjnie i nie wskazuje na to, że dany produkt jest wyprodukowany przez podanego producenta. Zawartość katalogu może ulec zmianie bez wcześniejszego informowania o tym. Wszystkie użyte zdjęcia, rysunki, nazwy marek, opis i numery służą tylko do identyfikacji.



Запчасти из настоящего списка, как правило, имеются в запасе, если только он не распродан. Прочие, не фигурирующие в списке артикулы, могут быть поставлены в самые кратчайшие сроки. Указание оригинальных номеров производителя не предполагает обязательного оригинального происхождения самих деталей. Данный список может изменяться без предварительного уведомления. Все использованные фото, рисунки, иллюстрации, названия брендов, наименования и номера служат исключительно для цели идентификации.

Visitez notre site :
www.bepcoparts.com

© **bepco 2016**

Tous droits réservés. Aucune partie de ce catalogue ne peut, ni intégralement, ni partiellement être reproduite ou communiquée (copiée, sauvegardée, utilisée dans un système de sauvegarde de données, etc) sous n'importe quelle forme, soit numérique ou mécanique, sans accord préalable et explicite de la société BEPCO PARTS.

- BEPCO est un fournisseur de pièces de rechange et accessoires d'après-vente qui sont appropriés pour l'entretien et la réparation des équipements OEM. Les Références OEM et marques sont à titre purement indicatif et ne signifient pas que les accessoires et/ou pièces de rechange viennent du fabricant de l'équipement ou des pièces d'origine.
- Les produits qui ne sont pas conformes aux exigences réglementaires concernant la conformité de la CE ne sont pas mis sur le marché dans l'Espace économique européen.
- BEPCO® est une marque déposée.
- Toutes les ventes sont soumises aux termes et conditions générales de vente sur www.bepcoparts.com
- Les photographies et les illustrations sont inclus à titre de référence seulement. Sous réserve d'erreurs d'impression.

Visit us on the Internet:
www.bepcoparts.com

© **bepco** 2016

All rights reserved. No part of this catalogue may be reproduced or communicated in any form or by any means, electronic or mechanical, including copying, recording or use in an information storage or retrieval system, without prior and explicit permission of BEPCO PARTS.

- BEPCO is a supplier of after-market spare parts and accessories that are suitable for the maintenance and repair of OEM-equipment. OEM references and brands are purely indicative and do not imply that the accessories and/or spare parts are coming from the original equipment or parts manufacturer.
- Products that do not comply with regulatory requirements concerning CE conformity are not placed on the market in the European Economic Area.
- BEPCO® are registered trademarks.
- All sales are subject to the general terms & conditions of sale on www.bepcoparts.com
- Photographs and illustrations are included for reference purposes only. Printing errors reserved.

Pièces détachées
de A à Z
toutes marques

Spare parts
from A-Z for
all brands

- Case IH
- David Brown
- Fendt
- Fiat
- Ford
- Hürlimann
- JCB
- John Deere
- K.H.D. (Deutz)
- Kubota
- Landini
- Lamborghini
- Manitou
- Massey Ferguson
- Mc Cormick
- Merlo
- New Holland
- Renault
- Same
- Steyr
- Valmet**
- Zetor

moving forward in every field

REF. 90/999-285